

*Protege ZM User Guide*



*PROTEGE ZM PORTABLE GAS  
MONITOR*

087-0047

Rev B







---

# ***Protege ZM User Guide***

## ***PROTEGE ZM PORTABLE GAS MONITOR***

087-0047

Rev B

© 2012 Scott Safety. SCOTT, the SCOTT SAFETY Logo, Protege, Proton, Scout, Freedom, Masterdock are registered and/or unregistered marks of Scott Technologies, Inc. or its affiliates.

All rights reserved. No part of this documentation may be reproduced in any form or by any means or used to make any derivative work (such as translation, transformation, or adaptation) without written permission from Scott Safety.

Scott Safety reserves the right to revise this documentation and to make changes in content from time to time without obligation on the part of Scott Safety to provide notification of such revision or change.

Scott Safety provides this documentation without warranty, term, or condition of any kind, either implied or expressed, including, but not limited to, the implied warranties, terms or conditions of merchantability, satisfactory quality, and fitness for a particular purpose. Scott Safety may make improvements or changes in the product(s) described in this documentation at any time.

While every effort has been made to ensure accuracy in this guide, no responsibility can be accepted for errors or omissions. This publication is not intended to form the basis of a contract, and the company reserves the right to amend the design, content, and specifications of the detector without notice.

Scott Safety, 4320 Goldmine Road, Monroe, NC 28110, Telephone 800-247-7257, FAX 704-291-8330, E-mail [scotttechsupport@tycoint.com](mailto:scotttechsupport@tycoint.com), Web [www.scottsafety.com](http://www.scottsafety.com)

Microsoft, Windows, Windows 2000, Windows Me, Windows XP, Windows NT, Windows Vista, Windows 7, Internet Explorer and MS-DOS are either trademarks or registered trademarks of Microsoft Corporation in the United States and other countries. Solaris and JAVA are either trademarks or registered trademarks of Sun Microsystems, Inc. All other products or service names are the property of their respective owners.

The international transport of this device is regulated under United States export regulations and may be regulated by the import regulations of other countries.

	<b>About This Guide</b>	
	Guide Overview .....	xi
	Guide Conventions .....	xii
	Related Product Documentation .....	xii
	Revision History .....	xii
	Certifications and Approvals .....	xiii
	General Safety Information .....	xiv
	Warnings and Cautions – Monitor Use and Care .....	xv
	Warnings and Cautions – Sensor Use and Care .....	xvi
	Warnings and Cautions – Battery Use and Care .....	xvi
<b>CHAPTER 1</b>	<b>Introduction</b>	
	Chapter Overview .....	1
	Device Overview .....	2
	Verifying Items Shipped .....	3
<b>CHAPTER 2</b>	<b>Operation</b>	
	Chapter Overview .....	5
	Operating the Monitor .....	6
	Powering Up the Monitor .....	7
	Monitor LCD Alerts & Alarms .....	8
<b>CHAPTER 3</b>	<b>Maintenance</b>	
	Chapter Overview .....	9
	Testing the Monitor .....	10
	Bump Testing Using Calibration Adapter .....	10
	Calibrating the O2 Monitor Using the Front Button .....	11
	Maintenance .....	12
	Self-Testing the Monitor .....	12
	Clearing a Bump Test Interval Alarm Alert .....	13
	Error Codes .....	14
<b>APPENDIX A</b>	<b>Specifications</b>	
	Appendix Overview .....	15
	Specifications .....	16
<b>APPENDIX B</b>	<b>Sensor Information</b>	
	Appendix Overview .....	17
	Gas Interferences .....	18

**APPENDIX C**

**Support**

Appendix Overview .....	19
Technical Service .....	20
Parts List .....	22
Warranty Statement .....	23

<b>Index</b> .....	25
--------------------	----

# **SCOTT LIST OF FIGURES**

<b>1</b>	Major Parts of the Monitor . . . . .	<b>3</b>
<b>2</b>	Monitor LCD Indicators . . . . .	<b>6</b>
<b>3</b>	Bump Test - Calibration Adapter Attached . . . . .	<b>11</b>

VIII LIST OF FIGURES



# **SCOTT LIST OF TABLES**

<b>1</b>	Scott Safety Documentation Set . . . . .	<b>xii</b>
<b>2</b>	Protege ZM User Guide Revision History . . . . .	<b>xii</b>
<b>3</b>	Certifications and Approvals for Monitor . . . . .	<b>xiii</b>
<b>4</b>	Available Monitor Options . . . . .	<b>2</b>
<b>5</b>	Major Parts of the Monitor . . . . .	<b>3</b>
<b>6</b>	Monitor LCD Items and Descriptions . . . . .	<b>6</b>
<b>7</b>	Monitor Power-Up Sequence . . . . .	<b>7</b>
<b>8</b>	Monitor Alerts and Alarms Descriptions . . . . .	<b>8</b>
<b>9</b>	Self-Test Steps . . . . .	<b>12</b>
<b>10</b>	Protege ZM Error Codes . . . . .	<b>14</b>
<b>11</b>	Monitor Specifications . . . . .	<b>16</b>
<b>12</b>	Gas Interferences . . . . .	<b>18</b>
<b>13</b>	Applicable Parts List . . . . .	<b>22</b>



---

## Guide Overview

This guide describes the steps required to use the Protege ZM Portable Gas Monitor. This document is for gas detection personnel to manage their gas monitoring device. This document contains information on operation and maintenance.

This user guide assumes a basic knowledge of gas detection procedures.

The user guide is divided into the following topics:

- [Introduction](#)
- [Operation](#)
- [Maintenance](#)
- [Specifications](#)
- [Sensor Information](#)
- [Support](#)



**Warning:** *Read, understand and follow the entire content of this guide prior to use. Failure to do so may result in serious injury or death.*

**Guide Conventions**

The following visual elements are used throughout this guide, where applicable:



**Warning:** This icon and text indicate a potentially hazardous situation, which, if not avoided, could result in death or injury.



**Caution:** This icon and text indicates a potentially dangerous procedure. Instructions contained in the warning must be followed. Failure to do so may result in damage to the device.



This icon and text indicate the possibility of electrostatic discharge (ESD) in a procedure that requires the reader to take the proper ESD precautions.



This icon and text designates information of special note.

**Related Product Documentation**

Table 1 lists the Scott Safety Family documentation set.

**Table 1** Scott Safety Documentation Set

DOCUMENT NAME	PURPOSE	DOCUMENT ID
Protege ZM User Guide	Provides information on operation and maintenance on the Protege ZM monitor.	087-0047
Protege ZM System Guide	Provides information on installation, configuration, operation, maintenance and troubleshooting on the Protege ZM monitor, test station, applicable software and firmware.	087-0048

**Revision History**

Table 2 shows the revision history for this guide, providing a description of the changes.





**Table 2** Protege ZM User Guide Revision History

REVISION	CHANGE
A	<ul style="list-style-type: none"> <li>Initial release.</li> </ul>
B	<ul style="list-style-type: none"> <li>Specifications chapter – Clarified Temperature Ranges.</li> </ul>

**Certifications and Approvals**

Table 3 indicates the monitor has been tested and complies with the following.

**Table 3** Certifications and Approvals for Monitor

<b>MARK</b>
 <p>Class I, Groups A, B, C, D T4          -50°C to +50°C (O<sub>2</sub>)          -40°C to +50°C (H<sub>2</sub>S)          -30°C to +50°C (CO)</p>
 <p>Ex ia IIC T4 Ga          Ambient temperature:          -50°C to +50°C (O<sub>2</sub>)          -40°C to +50°C (H<sub>2</sub>S)          -30°C to +50°C (CO)</p>
 <p>ATEX Directive          EMC Directive</p>
 <p>Ex ia IIC T4 Ga          Ambient temperature:          -50°C to +50°C (O<sub>2</sub>)          -40°C to +50°C (H<sub>2</sub>S)          -30°C to +50°C (CO)</p>

## General Safety Information



Ensure you adhere to the following for your safety.

**Warning:** *Read and follow the entire content of this guide prior to use. Failure to do so may result in serious injury or death.*



**Warning:** *All individuals who have or will have responsibility for using or testing this product must read and understand the contents of this manual. The product will perform as designed only if used and tested in accordance with the manufacturer's instructions. Failure to follow manufacturer's instructions will render the warranty and approvals null and void. Failure to follow these instructions may also result in serious injury or death.*

Scott Safety can take no responsibility for use of its equipment if it is not used in accordance with the instructions. If further operational or maintenance details are required but not provided in this guide, contact Scott Safety or their agent. Scott Safety shall not be liable for any incidental or consequential damages in connection with any modifications, errors or omissions in this guide.

All pertinent state, regional, and local safety regulations must be observed when installing and using this product. For reasons of safety and to assure compliance with documented system data, repairs to components should be performed only by the manufacturer.

Additionally, industry standards, codes, and legislation are subject to change. Updated copies should be obtained by users to ensure the most recently issued regulations, standards and guidelines are available.

All pertinent state, regional, and local safety regulations must be observed when handling and disposing of hazardous material, Toxic (E-Chem) Sensors, batteries and other similar items that may fall under the classification of hazardous material.

The Electrical, Electronic and Battery elements of this product must not be disposed of via municipal waste streams; they should be delivered to collection facilities. Information on collection facilities is given by the local authorities or importer's representative. Correct disposal will contribute to recycling of materials and prevent negative consequences for the environment.

For products sold in Europe, the end of life procedures for Battery operated Electronic products must comply with the RoHS Directive 2002/95/EC, the WEEE Directive 2002/96/EC and the Battery Directive 2006/66/EC. These directives dictate how to dispose of the electronic and battery elements of the product after use. For Protégé products sold in the UK only, Scott Safety Ltd has provided a collection service. This service can be accessed by Telephoning Customer Services on 01695 711711 who will be happy to assist. Please do not send products back to Scott. In other parts of Europe, other systems are in place. Please contact your local provider of Scott products for more details.

Only use Scott Safety approved replacement parts.

## Warnings and Cautions – Monitor Use and Care

Ensure you follow the applicable warnings and cautions indicated here.



**Warning:** *This equipment must be operated and serviced by qualified personnel only. Read and understand the guide completely before operating or servicing. Qualified personnel as defined according to local, county, state, federal and individual company standards.*



**Warning:** *Do not attempt part replacement or substitution as this could impair the intrinsic safety rating and will void the warranty of the product.*



**Warning:** *Do Ne pas essayer de la remplacer une partie ou la substitution, car cela pourrait nuire a la cote de securite intrinseque et annulera la garantie du produit.*



**Warning:** *When in doubt vacate the area immediately. You should vacate the area immediately should the monitor indicate a warning or alarm condition. You should know, understand and follow your company's safety protocols.*



**Warning:** *Ensure the atmosphere is free from toxic gases prior to starting any of the procedures.*



**Warning:** *When the primary monitor is off line, ensure you have another online monitor to actively detect gases. The monitor may be off line due to such activities, like but not limited to, calibration, installation, maintenance, troubleshooting, configuration, wiring and other activities.*



**Warning:** *If the monitor does not function as described herein, remove from service and mark for maintenance. Only use Scott Safety replacement parts where applicable.*



**Warning:** *Only use the monitor to monitor the atmosphere for the gases and concentrations for which it is set-up to detect.*



**Warning:** *To prevent ignition of an explosive atmosphere, read and adhere to the manufacturer's live maintenance procedures.*



**Warning:** *Read this manual for intrinsic safety precautions. Substitution of components may impair intrinsic safety, resulting in serious injury or death.*



**Warning:** *Perform a bump test every day. Failure to perform a daily functional test could lead to serious injury or death.*



**Caution:** *Monitor will not operate without power applied. Thus, it only detects gases while powered.*



**Caution:** *Periodically test for correct operation of the system's alarm events by exposing the monitor to a targeted gas concentration above the high alarm set point.*



**Caution:** *Verify the gas inlet ports are free of dirt and debris prior to use.*



**Caution:** *Do not expose the monitor to severe mechanical or electrical shock. Always conduct device startup and bump test procedures after such exposure to verify the monitor's operation and accuracy.*

---

**Warnings and  
Cautions – Sensor  
Use and Care**

Ensure you follow the applicable warnings and cautions indicated here.



**Warning:** *Extended exposure of the detector to high concentrations of toxic gases may result in degraded sensor performance. If an alarm occurs due to high concentration of toxic gases, exit to a safe area, bump test, recalibrate if necessary or, if needed, call us.*

---

**Warnings and  
Cautions – Battery  
Use and Care**

Ensure you follow the applicable warnings and cautions indicated here.



**Caution:** *No attempt should be made to alter or repair the monitor.*



**Caution:** *Do not attempt to replace the monitor's battery. It is not replaceable.*



**Caution:** *Discard monitor as soon as the battery indicator shows fully discharged battery.*



## Chapter 1



---

### Chapter Overview

This chapter covers the following topic:

- [Device Overview](#)

## Device Overview

The Protege ZM is a portable clip-on one (1) gas disposable monitor that is operated with a single button and has a two (2) year life span (typical). Comes with a non-field replaceable lithium-ion battery, filter and sensor already installed and ready for use.

Gas indication displays via a direct reading backlit LCD, multiple bright LEDs, a loud audible alarm and a vibratory alarm. The monitor includes a downloadable data log for twenty-five (25) events and records denoting exposures, calibrations, and gas values.

The personal gas detection monitor is designed for monitoring the atmosphere for potentially hazardous levels of gases. Select from three (3) types: Hydrogen Sulfide (H<sub>2</sub>S), Carbon Monoxide (CO) and Oxygen (O<sub>2</sub>) enrichment or depletion. [Table 4](#) lists their available options.

**Table 4** Available Monitor Options

ITEM	HIBERNATE MODE OPTION	FACTORY DEFAULT ALARM SET POINTS*
Oxygen (O <sub>2</sub> )	No	Low=19.5% High=23.5%
Hydrogen Sulfide (H <sub>2</sub> S)	Yes	Low=10PPM High=15PPM
Carbon Monoxide (CO)	Yes	Low=35PPM High=200PPM
* Customer may change these set points using the IR Connect after delivery. To display the monitor alarm set points, press the button on the front of the monitor. Also, set points may be ordered with custom values from the factory.		

If you have any questions about the monitor or its operation contact Scott Safety. See [“Technical Service” on page 20](#).

[Figure 1](#) shows the major parts of the monitor.

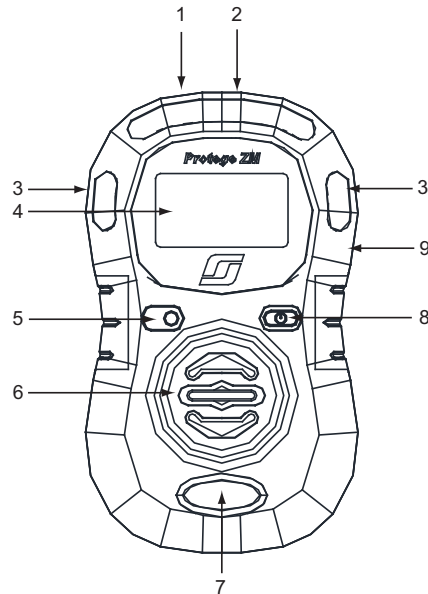
**Figure 1** Major Parts of the Monitor

[Table 5](#) lists the major parts of the monitor.

**Table 5** Major Parts of the Monitor

REFERENCE NUMBER	ITEM
1	LED alarm (top)
2	IR Interface Port (back)
3	LED alarms (2, side)
4	LCD
5	Audible Alarm Port
6	Gas Inlet Port
7	Gas Label
8	Operation Button
9	Alligator Clip (back)

### **Verifying Items Shipped**

This section provides a list of the items that typically ship with the monitor. Ensure you have all items, if not See [“Technical Service” on page 20](#).

- The Monitor
- Calibration Adapter
- Protege ZM Gas Detector CD
- Alligator Belt Clip



## Chapter 2



---

### Chapter Overview

This chapter covers the following topics:

- [Operating the Monitor](#)

## Operating the Monitor

This section describes the operational modes of the monitor.



**Warning:** If the monitor fails to respond properly upon start up, or if calibration is out of date, do not use the device until it has been properly calibrated. Failure to do so could result in death or injury. Additionally, when the monitor's LCD is blank and it does not respond it means the two year life has expired.

The monitor uses a special high viewing angle LCD designed to enhance the screen visibility. In the absence of gas, it displays life remaining. In those cases where gas is present, the display automatically shifts to a display that shows the gas concentration and a battery icon.

To activate the monitor, press and hold down the front button for about five (5) seconds. On activation, the monitor vibrates, flashes and sounds an audible alarm. A successful activation displays the life remaining in months on the LCD as 24 months. See “Powering Up the Monitor” on page 7.



The displayed number (for normal mode) appearing on the monitor's LCD, may be changed using the Display parameter of the IR Connect Software.

Figure 2 shows the LCD items.

**Figure 2** Monitor LCD Indicators



Table 6 lists the LCD items and their descriptions.



**Warning:** If monitor does not operate in the manner described here, do not use. Tag it out of service. Failure to ensure it is properly operating may result in serious injury or death.



**Warning:** You must familiarize yourself with the icons in both the non-alarm and alarm states.



**Warning:** If the display is missing icons or cannot be clearly read, please contact us.

**Table 6** Monitor LCD Items and Descriptions

REFERENCE NUMBER	DESCRIPTION
1	Alarm Condition Icon
2	Self-Test Status Icon
3	Test Reminder Icon – Display indicates self-test needed
4	Gas Type Icon

**Table 6** Monitor LCD Items and Descriptions (continued)

REFERENCE NUMBER	DESCRIPTION
5	Battery Indicator Icon (Used During Real-Time Gas Reading)
6	Instrument Life Remaining or Real Time Gas Reading Data
7	High and Low Alarm Set Point Icons
1/7	Alarm Condition Icons
6/8	Instrument Life Remaining Icons
9	Infrared Data Transfer Icon
10/11	Months/Days/Hours Since Last Maximum Exposure
6/11	Instrument Life Remaining Indicator Data and Icon

**Powering Up the Monitor**

This section describes the power up sequence.



**Warning:** *If the monitor does not operate in this fashion, do not use. Tag it out of service. Failure to do so may result in serious injury or death.*

Table 7 details the sequence.





**Table 7** Monitor Power-Up Sequence

ACTION	LCD	RESULTS
Press and hold down the button for five (5) seconds.		The monitor starts and runs through a self-test. During the self-test ensure the following: <ul style="list-style-type: none"> <li>• The monitor emits one audible beep</li> <li>• All LEDs light and monitor vibrates</li> <li>• All LCD display elements appear</li> </ul>
		After the full element LCD displays, the low alarm and high alarm set points display.
		When a self-test is successful the monitor turns to the original screen showing Months with Clock icon and displays a CHECK MARK and one short audible beep sounds.

**Monitor LCD Alerts & Alarms**

This section describes various alerts and alarms. [Table 8](#) lists the details.

**Table 8** Monitor Alerts and Alarms Descriptions

LCD	REASON	LED	BEEPS	VIBRATION
	Low Alarm	1 slow flash every second	1 slow beep every second	1 slow vibration every second
	High Alarm and Over Limit (OL) Alarm	2 fast flashes every second	2 fast beeps every second	2 fast vibrations every second
	Detector Life Countdown Alarm*	8 slow flashes per minute	8 slow beeps per minute	8 slow vibrations per minute
	Bump Test Due**  Note: LCD toggles between BUP & reading.	Emits alternating flashes (left and right) every 5 seconds		
<p>* When the Monitor remaining clock displays 0 hours the detector operates for 8 hours before deactivating.                      ** This applies only when a bump test interval is set.</p>				



## Chapter 3



---

### Chapter Overview

This chapter covers the following topics:

- [Testing the Monitor](#)
- [Maintenance](#)
- [Error Codes](#)

## Testing the Monitor

This section covers calibration of the monitor.



**Warning:** *Operating a device that has exceeded its calibration date can cause false readings of detected gases. Readings obtained while monitor is out of calibration are invalid and could lead to death or injury.*

Scott Safety recognizes the potential of the monitor as a life saving device when operated and maintained correctly. As such, verifying proper operation of the monitor in the form of Calibration and regular Bump Testing is essential to ensure the monitor performs as intended in a potentially hazardous environment.

The frequency at which Calibration and Bump Testing occur is best determined based on local regulatory standards, company policies, and industry best practices. Scott Safety is not responsible for setting policies or practices.

- Calibration — Is performed to ensure the device detects target gases within specified operating parameters. Calibration is the adjustment of the monitor's response to match a known concentration of gas. Sensors can lose sensitivity through normal degradation, exposure to high gas concentrations, or sensor poisoning.

## Bump Testing Using Calibration Adapter

This section describes how to perform a manual Bump Test.

Equipment required:

- Calibration gas – Verify concentration level exceeds set points of monitor and expiration date of cylinder has not passed.
- Tygon tubing – 2 feet of 3/16" ID
- Regulator – Set to provide flow at 0.5LPM
- Calibration Adapter – Shipped with monitor

- 1 Verify the concentration level of the target gas in the cylinder exceeds alarm settings of the monitor.
- 2 Attach the Regulator to the gas cylinder and verify cylinder pressure.
- 3 Connect Tygon tubing to both the Regulator and Calibration Adapter.
- 4 Attach Calibration Adapter to monitor and apply gas. See [Figure 3](#).

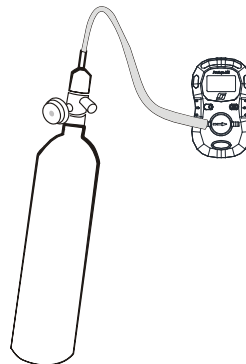

*Ensure the Calibration Adapter is fitted onto the monitor with the Arrow Head pointing to the right for proper flow. Additionally, ensure the tubing from the Regulator is attached to the Calibration Inlet (Non Arrow end).*

**Figure 3** Bump Test - Calibration Adapter Attached

- 5 Verify monitor responds to target gas and activates the visual, audible, and vibrating alarms.
- 6 Turn off gas cylinder and remove Calibration Adapter.



**Warning:** *If the monitor fails to activate all alarms within one (1) minute, the monitor must be taken out of service and tagged. Failure to do so could lead to death or injury.*

### **Calibrating the O<sub>2</sub> Monitor Using the Front Button**

This section describes how to calibrate a O<sub>2</sub> monitor using only the front button.



**Warning:** *Only perform O<sub>2</sub> calibration in normal air (20.9% Oxygen) that is free of hazardous gases.*

- 1 Press and hold the front button for four (4) seconds.
- 2 CAL displays and the O<sub>2</sub> icon flashes in the lower left hand corner.
- 3 After a successful calibration, the monitor emits one (1) beep, vibrates and the LEDs flash.
- 4 After an unsuccessful calibration, the monitor does not beep or flash and continues to display CAL. If after a few failed calibrations, please contact us.

**Maintenance**

This section covers maintenance requirements.

**Self-Testing the Monitor**

This section covers self-testing the monitor.

Prior to daily use, the device prompts to perform a self-test. This process is a simple and effective way to ensure safe operation of the monitor. During the self-test, the audio, visual and vibration alarms are activated and the sensor is tested. [Table 9](#) details a step by step process for performing the self-test.



**Warning:** *The Self-test does not take place of a Bump Test or a Calibration to ensure the monitor response to gas.*

**Table 9** Self-Test Steps

LCD	STEPS
	When the TEST icon appears in the upper left hand corner, a self-test is required. Press the button on the front of the monitor to perform the self-test.
	After pressing the button this screen appears. During the self-test ensure the following occurs: <ul style="list-style-type: none"> <li>• The monitor emits one audible beep</li> <li>• All LEDs light and monitor vibrates</li> <li>• All LCD display elements appear</li> </ul>
	After the full element LCD displays, the low alarm and high alarm set points display. Note: Once a self-test is performed successfully, the Check Mark appears automatically, and the High and Low set points display.
	Note: Provided the monitor has not been exposed to gas, this displays. Otherwise, go to the next step. When a self-test is successful the monitor turns to the original screen and displays a CHECK MARK in place where the TEST icon was previously displayed and one short audible beep sounds. The monitor by default prompts another self-test in twenty (20) hours from when the button was pressed.
	(If applicable) If programmed with a USER ID, after the alarm set points are displayed, a combination of numbers or letters scrolls across the LCD. This includes a maximum of two (2) screens with a maximum character limit on the USER ID of six (6) characters.
	(If applicable) If the monitor has been exposed to gas exceeding the low alarm set point, a value appears with MAX next to it. This represents the peak value (highest) that the monitor has seen. After this screen, another appears displaying a value with (hours, days, or months), this represents the amount of time past since the peak reading.

**Table 9** Self-Test Steps (continued)

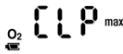
LCD	STEPS
	<p>(If applicable) After the peak reading and time since screens, another screen displays with CLP (Clear Last Peak).                      If you press the button while this is displayed, the peak value on the monitor resets.                      Note: The value is cleared from the display, but the value is stored in the monitor's event log. This value may be cleared on the next screen.</p>



**Caution:** If the self-test fails, the monitor emits five (5) short beeps and flashes before displaying TEST.



**Caution:** If the self-test fails three (3) consecutive times the monitor enters Fail Safe mode. Please contact us for a replacement.



**Caution:** During normal operations, the battery is continuously monitored. If the battery is low for more than three (3) hours the monitor enters Fail Safe mode.



**Caution:** If the battery self-test fails five (5) consecutive times the LCD goes blank. In case of a blank LCD, discontinue use and contact us for a replacement.

### **Clearing a Bump Test Interval Alarm Alert**

This section describes clearing a Bump Test Interval Alarm Alert.



*The monitor typically ships with the Bump Interval parameter default setting of 0 days. However, it may be set to alert you if a bump test is due.*

When a monitor is due for a bump test, the monitor emits alternating flashes (left and right) every five (5) seconds. And the TEST icon remains even after the front button is pushed.

This alarm alert may be cleared using one of two (2) methods:

- Manually using the monitor – To clear using this method, press the front button down once. It displays numerous screens, then displays the word GAS while the TEST icon flashes. The monitor waits 45 seconds for the target gas to be applied, or a button press to skip the bump test.

---

**Error Codes**

Table 10 provides a list of error codes for the Protege ZM.

**Table 10** Protege ZM Error Codes

<b>ERROR CODES</b>	<b>CAUSE</b>
E01	Configuration memory corrupt
E02	Gas memory corrupt
E03	Program memory corrupt
E05	Bad battery
E06	Bad sensor

## Appendix A



---

### Appendix Overview

This appendix covers the following topic:

- [Specifications](#)

**Specifications**

Table 11 lists the monitor's specifications.

**Table 11** Monitor Specifications

<b>MONITOR SPECIFICATIONS</b>		
Battery Life	2 years, 4 minutes of alarm time per day	
Alarms	Visual, vibrating, audible (95dB)	
Tests	Full function self-test on activation and every 20hours; continuous automatic battery tests	
Data Log	Last 25 events	
Housing	Impact Absorbent Overmold	
Hydrogen Sulfide	Range	1 to 100PPM, 1PPM
	Low Alarm Set Point	10PPM*
	High Alarm Set Point	15PPM*
	Calibration Gas Concentration	25PPM
Carbon Monoxide	Range	1 to 300PPM, 1PPM
	Low Alarm Set Point	35PPM*
	High Alarm Set Point	200PPM*
	Calibration Gas Concentration	100PPM
Oxygen	Range	1 to 30% Volume, 0.1%
	Low Alarm Set Point	19.5%*
	High Alarm Set Point	23.5%*
	Calibration Gas Concentration	16%
Dimensions	3.7Hx2.2Wx1.3"D (94Hx56Wx33mmD)	
Weight	2.7oz (76g)	
Intrinsically Safe Approved Temperature Range	H <sub>2</sub> S: -40 to +122°F (-40 to +50°C) CO: -22 to +122°F (-30 to +50°C) O <sub>2</sub> : -58 to +122°F (-50 to +50°C) IS approved temperature may not reflect the operating temperature.	
Operating Temperature Range	H <sub>2</sub> S, CO and O <sub>2</sub> : 14 to +122°F (-10 to +50°C) For values outside this temperature range, you may experience reduced performance or alarm functionality.	
Operating Humidity	5% to 95% RH, Non-Condensing	
*Note: These values are factory defaults. These values may be changed.		



## Appendix B



---

### Appendix Overview

This appendix covers the following topic:

- [Gas Interferences](#)

## Gas Interferences

There are known gas interferences to a limited number of chemical compounds. Scott Safety attempts to identify possible gas interferences to which gas sensors may be exposed; however, not all chemical compounds that presently exist have been tested. [Table 12](#) provides known toxic gas interferences.



[Table 12](#) does not show, nor should it be implied, that no additional interferences may occur. These selectivity ratios are used as guides only. They are not to be used as calibration factors. The gas species' actual cross-sensitivities may vary from the values shown.

Keys for [Table 12](#).

- Zero – Indicates tested and confirmed no interferences
- Blank – Indicates not tested
- Neg – Indicates gas produces a negative signal
- Two values in a cell – Indicates initial peak and finish offset (unstable or transition gas) and should not be used for cross calibration

**Table 12** Gas Interferences

		SENSOR TYPES (ALL VALUES IN PPM)	
		CO	H <sub>2</sub> S
Interference Gas	CO	1	< 0.02
	H <sub>2</sub> S	< 0.02	1
	SO <sub>2</sub>	0	=0.3
	NO	<0.1	
	H <sub>2</sub>	<0.4	<0.1
	C <sub>2</sub> H <sub>5</sub> OH	0	= -0.005
Key: < Less than; ~ Approximate. For each sensor type, the table shows how 1ppm of an Interference Gas appears on that specific sensor type. For example, 1ppm CO appears as less than <0.02ppm on a H <sub>2</sub> S sensor.			

## Appendix C



---

### Appendix Overview

This appendix covers the following topics:

- [Technical Service](#)
- [Parts List](#)
- [Warranty Statement](#)

---

## Technical Service

Congratulations on your purchase of a Scott Safety product. It is designed to provide you with reliable trouble-free service.

Contact us, if you have technical questions, need support, or if you need to return a product.



When returning a product, contact Technical Support to obtain a Return Material Authorization (RMA) number prior to shipping for service repairs.

North America  
 Scott Safety  
 Monroe Corporate Center  
 4320 Goldmine Road  
 Monroe, NC 28110-9346 USA  
 Technical Support Telephone: 1-800-247-7257  
 Technical Support FAX: 704-291-8330  
 E-Mail: [scotttechsupport@tycoint.com](mailto:scotttechsupport@tycoint.com)  
 Web Site: <http://www.scottsafety.com/>

United Kingdom  
 Scott Safety  
 Pimbo Road  
 Skelmersdale, Lancashire  
 WN8 9RA, UK  
 Telephone: +44 (0)1695 727 171  
 E-Mail: [scottint.uk@tycoint.com](mailto:scottint.uk@tycoint.com)  
 Web Site: <http://www.scottsafety.com/>

Australia / New Zealand  
 Scott Safety  
 Customer Service  
 137 McCredie Road  
 Guildford, NSW 2161, Australia  
 Telephone: 131 772  
 E-Mail: [scott.sales.ANZ@tycoint.com](mailto:scott.sales.ANZ@tycoint.com)

Finland  
 PO Box 501  
 FI-65101, Vaasa  
 Finland  
 Telephone: +358 (0)6 3244 543, 544, tai 555  
 Fax: +358 (0)6 3244 591  
 E-Mail: [scott.sales.fin@tycoint.com](mailto:scott.sales.fin@tycoint.com)

Russia  
5 floor, 1 Timiriazevskaya str.  
Moscow, 125422  
Russia  
Telephone: +7 (495) 661-14-29  
E-Mail: scott.sales.russia@tycoint.com

Germany  
Telephone: 0180 1111 136  
Fax: 0180 111 135  
E-Mail: scott.sales.ger@tycoint.com

France  
Telephone: 08 21 23 02 38  
Fax: 08 21 23 02 37  
E-Mail: scott.sales.france@tycoint.com

UAE  
Telephone: +971 (02) 445 2793  
Fax: +971 (02) 445 2794  
E-Mail: scott.sales.emirates@tycoint.com







China  
China, Beijing, Technical Support Office  
Beijing branch, Shanghai Eagle Safety Equipment Co. Ltd.  
Suite 708, Scitech Tower, No.22 Jianguomenwai Avenue, Chaoyang District, Beijing,  
100004, P.R.China  
Telephone: +86-10-65150005

Asia  
Scott Safety – Asia  
Service Dept  
2 Serangoon North Ave 5, #07-01  
Singapore 554911  
Telephone: +65. 6883 9671  
Fax:+65. 6234 2691  
E-Mail: hokchan@tycoint.com

**Parts List**

Table 13 provides a parts list.

**Table 13** Applicable Parts List

CATEGORY	ITEM	DESCRIPTION	PART NUMBER
Monitor		Monitor	096-3459-xx -01= CO (Red) -02= H <sub>2</sub> S (Red) -03= O <sub>2</sub> (Red)
Accessories for Monitor		Calibration Cap/Adapter	074-0564
		Tygon Tubing 3/16"ID, 10' length, Soft (For Non-Reactive gases)	096-3167
		Alligator Belt Clip	073-0355
Manual		Protege ZM Gas Detector CD	096-3474
Gas Cylinders & Regulator		H <sub>2</sub> S Single Gas Cylinder 25ppm, 34L bottle, (500PSI)	077-0272
		CO Single Gas Cylinder 100ppm, 103L bottle, (1000PSI)	077-0246
		O <sub>2</sub> Single Gas Cylinder 16%, 6D (103L) bottle, (1000PSI)	077-0039
		Regulator, 0.5LPM (For Manual Calibration)	077-0018
Note: For calibration equipment, contact your Scott sales representative.			

---

**Warranty Statement**

Scott Safety (SCOTT) warrants the Protege ZM PORTABLE GAS DETECTION MONITOR PRODUCTS (THE PRODUCTS) to be free from defects in workmanship and materials under normal use and service for a period of two (2) years beginning upon the date of activation for all Protégé ZM Oxygen Monitors and All Other Protégé ZM Monitors for three (3) years from date of activation or 24 months of operational life, whichever occurs first. This warranty is valid only if the detector is activated within one year from the original date of manufacture by SCOTT.

This warranty applies to all components of THE PRODUCTS supplied at the time of original sale of THE PRODUCTS, EXCEPT consumable items.

SCOTT's obligation under this warranty is limited to replacing or repairing (at SCOTT's option) THE PRODUCTS or components shown to be defective in either workmanship or materials.

Only personnel of SCOTT or, when directed by SCOTT, authorized SCOTT agents are permitted to perform warranty obligations. This warranty does not apply to defects or damage caused by any repairs of or alterations to THE PRODUCTS made by owner or any third party unless expressly permitted by SCOTT product manuals or by written authorization from SCOTT.

To obtain performance under this warranty, and as a condition precedent to any duty of SCOTT, the purchaser must return such products to SCOTT, a SCOTT authorized distributor or a SCOTT authorized service center. See [“Technical Service” on page 20](#).

This warranty does not apply to any malfunction of or damage to THE PRODUCTS resulting from accident, alteration, misuse, or abuse.

THIS WARRANTY IS MADE IN LIEU OF ALL OTHER WARRANTIES, EXPRESSED OR IMPLIED INCLUDING, BUT NOT LIMITED TO, ANY IMPLIED WARRANTY OF MERCHANTABILITY OR FITNESS FOR A PARTICULAR PURPOSE. IN ADDITION, SCOTT EXPRESSLY DISCLAIMS ANY LIABILITY FOR SPECIAL, INCIDENTAL OR CONSEQUENTIAL DAMAGES IN ANY WAY CONNECTED WITH THE SALE OR USE OF SCOTT PRODUCTS, AND NO OTHER FIRM OR PERSON IS AUTHORIZED TO ASSUME ANY SUCH LIABILITY.





---

## A

Alerts & Alarms Descriptions

Monitor 8

Approvals and Certifications

Monitor [xiii](#)

Available Options

Monitor 2

---

## B

Battery Use and Care

Warnings and Cautions [xvi](#)

Bump Test

Calibration Adapter Attached 11

---

## C

Calibration Adapter Attached

Bump Test 11

Contact Information

Technical Support 20

---

## D

Device Use and Care

Warnings and Cautions [xv](#)

---

## E

Error Codes

Protege ZM 14

---

## G

Gas Interferences

Sensor Types 18

General Safety Information [xiv](#)

Guide Conventions [xii](#)

Guide Overview [xi](#)

---

## L

LCD

Monitor 6

---

## M

Major Parts

Monitor 3

Monitor

Alerts & Alarms Descriptions 8

Available Options 2

Certifications and Approvals [xiii](#)

LCD 6

Major Parts 3

Power-Up Sequence 7

Specifications 16

---

## P

Parts List 22

Power-Up Sequence

Monitor 7

Protege ZM

Error Codes 14

---

## R

Related Product Documentation [xii](#)

Revision history, for this guide [xii](#)

---

## S

Sensor Types

Gas Interferences 18

Sensor Use and Care

Warnings and Cautions [xvi](#)

Specifications

Monitor 16

---

## T

Technical Support

Contact Information 20

---

## W

Warnings and Cautions

Battery Use and Care [xvi](#)

Monitor Use and Care [xv](#)

Sensor Use and Care [xvi](#)







Monroe Corporate Center

P.O. Box 569

Monroe, NC 28111

Telephone: 800-247-7257

FAX: (704) 291-8330

Web: [www.scottsafety.com](http://www.scottsafety.com)