

MSA Cairns®
The Safety Company

MSA Cairns®
Fire and Rescue Helmets



WHEN YOU GO IN, WE GO IN WITH YOU.

Table of Contents

Choose MSA Cairns.....	3
MSA Cairns Helmets Overview.....	4-5
Key Safety Features.....	6
MSA Cairns Helmets.....	7-30
Leather Helmets.....	7-13
Traditional Helmets.....	14-21
Modern Fire & Rescue Helmets.....	22-29
Jet-Style Helmet.....	30-34
Presentation Helmets.....	35
Components & Options.....	36-45
Chinstraps.....	37
Earlaps.....	38
Eye & Face Protection.....	38-39
Fronts.....	40-51
MSA Cairns Stock-Order-Ship (SOS) Program.....	52-53
MSA Cairns Replacement Parts.....	54-60
Globe® Turnout Gear and Boots.....	61-62

Great Reasons to Choose MSA Cairns[®] Helmets



We've been proudly manufacturing fire helmets since 1836. And to this day when it comes to head protection, more first responders trust MSA Cairns brand fire helmets than any other. Here are just a few reasons why:

1 Shell Release System (SRS)

The MSA Cairns Shell Release System (SRS) helps to protect against impact and heat—even when your helmet is dislodged from your head. With the SRS, if your helmet comes off due to extenuating circumstances—such as a fall through a floor or roof, the impact cap is designed to separate from the helmet shell, **but remain on your head.**

2 Retractable MSA Cairns Defender[®] Visor

North America's first (and still the best) NFPA 1971 and ANSI/ISEA Z87.1 impact-rated, integral visor. The Defender Visor was designed with firefighters in mind: stowing away when not in use, deployed with gloved hands, and easily replaced. Replacement of the lens does not require special tools or disassembly of the helmet. All of these benefits make the Defender Visor the best-selling firefighting eye protection in the market.

3 Best In Class

In a recent survey of firefighters across the nation¹, the majority listed MSA Cairns brand as “best in class.” When you consider the combined effectiveness of our SRS, crumple-zone front holder, impact cap, and suspension—our fire helmets offer the most complete package on the market.

4 Soft Good Kits and Replaceable Chin Straps

In 2018, MSA Cairns led the industry by offering removable and replaceable soft goods for all structural firefighting helmets, including soft good kits for easy cleaning. Toolless removable chin straps are now standard on all MSA Cairns Fire Helmets.

5 MSA Cairns 10-Year Lifetime Warranty

MSA Cairns offers a 10-year lifetime warranty that the product will be free from defects in materials and/or faulty workmanship². When you factor in the quality, ease of maintenance, and unique safety features found **ONLY** in MSA Cairns Helmets, it's easy to see why firefighters are fiercely loyal to the MSA Cairns brand.



6 Same Day Shipping on Our Most Popular Items

When you can't afford to wait another day, MSA offers our most popular Cairns products in our Stock-Order-Ship (SOS) program. For these products, if your order is entered by 2:30 PM (EST), the product ships the same day from our warehouse in Pittsburgh, PA. Look for the SOS symbol  beside products in the program. Remember, too, you can always order customized Cairns Fire Helmets through Assemble-to-Order (ATO). ATO forms are on every fire helmet page on MSASafety.com.

¹Fire helmet brand assessment study conducted by an outside research firm for MSA.

²For MSA Cairns Fire Helmet Warranty details, please see www.MSAsafety.com. 10-year warranty applies to helmets manufactured on or after 1/1/2015. Limitations apply.

MSA Cairns Helmets Overview

				
	N6A Houston®	N5A New Yorker®	MSA Cairns 1010 & 1044	880 Tradition®
PAGE NUMBER	10	10	16	18
SHELL				
10-Year Warranty*	■	■	■	■
Country of Manufacture	US	US	US	US
Leather	■	■		
Fiberglass Composite			■	
Thermoplastic				■
SAFETY OPTIONS				
Impact/Thermal Cap	■	■	<i>See page 15 for details.</i>	■
Integral Eye/Face Protection			Defender Visor	
Shell Release System			■	
Crumple-zone Front Holder	■	■	■	■
ARFF Proximity System			■	
STANDARDS COMPLIANCE				
NFPA 1971 (structural)	■		■	■
NFPA 1971 (proximity)			■	
NFPA 1951 (rescue)				
OSHA 1910.156	■	■	■	■

Helmet Shell Material

Leather	<ul style="list-style-type: none"> The original MSA Cairns fire helmet 100% top-grain steer hide Impregnated with a natural resin system Hand-tooled by craftsmen N5A New Yorker & N6A Houston models available with Traditional, Bronx, or Boston Bend brim
Fiberglass Composite	<ul style="list-style-type: none"> Most popular MSA Cairns fire helmet material Durable shell material Available in matte or glossy finish 1010, 1044, 660C, 664 & HP3 models
Thermoplastic	<ul style="list-style-type: none"> Lightest weight material in the MSA Cairns line Available on XF1, 880 & 360S/R/R-13 models

Helmet Style Overview

Traditional	<ul style="list-style-type: none"> Classic fire helmet design Most popular MSA Cairns fire helmet style Generally lower profile than our competitors' traditional helmets Helmets: N5A, N6A, 1010, 1044 & 880
Modern	<ul style="list-style-type: none"> Lower profile than our traditional style Lower profile than most of our competitors' modern style helmets Helmets: 660C, 664, HP3, & 360S/R/R-13
Jetstyle	<ul style="list-style-type: none"> Lowest profile style Integrated accessories offer snag hazard reduction; includes eye/face protection, communication and lights Matte or glossy finishes Helmet: XF1

*10-Year Warranty applies only to MSA Cairns Fire Helmets manufactured on or after January 1, 2015. For details on MSA Cairns warranties, visit Fire Helmet product page on MSAFire.com.

				
	660C Metro® & Invader 664®	Commando HP3®	Structural 360S®	Cairns XF1
PAGE NUMBER	22	24	26	30
SHELL				
10-Year Warranty*	■	■	■	■
Country of Manufacture	US	US	US	France
Leather				
Fiberglass Composite	■	■		
Thermoplastic			■	■
SAFETY OPTIONS				
Impact/Thermal Cap	■	■	■	■
Integral Eye/Face Protection	Defender Visor	Defender Visor		Full Faceshield (NFPA) Visor (Z87+)
Shell Release System	■			
Crumple-zone Front Holder				
ARFF Proximity System	■			
STANDARDS COMPLIANCE				
NFPA 1971 (structural)	■	■	■	■
NFPA 1971 (proximity)	■			
NFPA 1951 (rescue)		■		■
OSHA 1910.156	■	■	■	■

Helmet Colors (Colors shown are approximate.)

	Black	Yellow	Red	White	Orange	Blue	Green	Pink
N6A Houston	■	■	■	■		■		
NSA New Yorker	■	■	■	■		■		
MSA Cairns 1010	■	■	■	■	■	■	■	■
MSA Cairns 1044	■	■	■	■				
880 Tradition	■	■	■	■	■	■		
660C Metro	■	■	■	■	■	■	■	■
Invader 664	■	■	■	■				
Commando HP3	■	■	■	■	■	■	■	
Structural 360S	■	■	■	■	■	■	■	
Cairns XF1*	■	■	■	■		■		

* Colors available in matte or glossy finish

MSA Cairns Fire & Rescue Helmets

Key Safety Features

MSA Cairns Shell Release System (SRS)



Available on 1010, 1044, 660C and 664.

The MSA Cairns Shell Release System is designed to provide a second level of protection if your helmet is struck by a collapsing structure, or caught during a fall through a floor or roof.

MSA Cairns ARFF Proximity System



- Consists of an aluminized bonnet and shroud as well as a 6" gold-coated face shield
- NFPA-1971 compliant for proximity use
- Does not interfere with your SCBA
- Easy to use
- Available on 1010*, 1044*, 660C and 664

**Compliant without front holder*

MSA Cairns Defender Visor



The original integrated, retractable eye protection.

- Our most popular eye protection option
- Meets NFPA 1971 and ANSI/ISEA Z87.1
- Stores inside your helmet so it:
 - deploys and stows easily
 - stays protected from heat and debris when not in use
 - doesn't block your front piece
 - never gets lost or misplaced
- Features a quick-disconnect system so you can easily maintain or change out lenses without tools
- Fits most firefighters, even with glasses
- Available on 1010, 1044, 660C, 664 and HP3
- Available as a user-upgrade kit for the same helmets (see page 54)

MSA Cairns Leather Helmets

Quality Craftsmanship

We've been making fire helmets for nearly 200 years—that's more than double most other fire helmet manufacturers. Since 1836, MSA Cairns leather fire helmets have retained the same authentic look and quality firefighters for generation after generation have relied on. Each helmet is individually handcrafted and ready to provide years of dependable service. MSA Cairns Leather Fire Helmets are the iconic symbol of pride in the fire service.



Hand-shaped



Hand-stitched

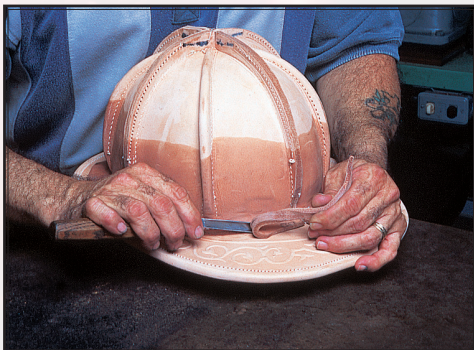

Hand-trimmed



MSA Cairns Leather Helmets

Handcrafted with Meticulous Detail

- The New Yorker N5A and Houston N6A shells are hand-constructed of 100% top-grain steer hide¹ and impregnated with a natural resin system, which is sealed and over-coated with a colored high-luster finish.
- The crown is hand-sewn to the one-piece brim section. Showing attention to detail in every stitch, the brim is embossed with the Original fire service vine pattern.

- The thermal impact liner is then installed within the leather crown. The thermal impact liner dramatically increases the levels of protection where you need it most.
- The Cairns six-way overhead strap suspension system reduces shock transmission while providing a deep, comfortable fit.
- Removable/washable soft goods are standard on every MSA Cairns Leather Fire Helmet².

N5A New Yorker Cut-Away

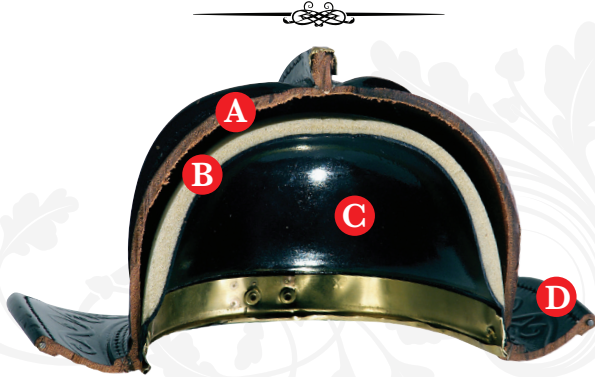

- A** 100% top-grain steer hide
- B** High temperature-resistant urethane foam
- C** ABS inner liner
- D** Sewn-over wire reinforcement

N6A Houston Cut-Away

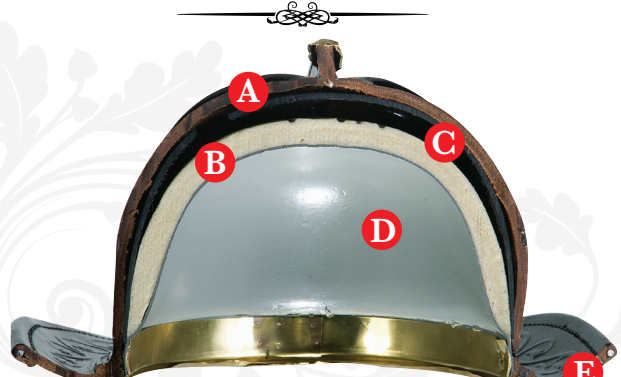

- A** 100% top-grain steer hide
- B** High temperature-resistant urethane foam
- C** Lexan outer dome
- D** ABS inner liner
- E** Sewn-over wire reinforcement

MSA Cairns Leather Helmet: 10-Year Warranty

MSA Cairns Helmets, especially leather helmets, have the reputation of being the most durable products on the market. When you factor in the quality, ease of maintenance and unique safety features found ONLY in MSA Cairns Helmets, it's easy to see why firefighters are loyal to the MSA Cairns brand.

A Growing Legacy

Even an icon like an MSA Cairns Leather Fire Helmet can be further elevated. MSA continues to innovate the leather fire helmet product line, while preserving the legacy and focusing on safety.

NFPA-compliant Bourkes

Combining the traditional look of Bourkes that were invented in the 1960s with modern materials, the NFPA compliant Bourkes satisfy the eye/face protection requirements as prescribed by NFPA-1971:2018, Standard on Protective Ensembles for Structural Fire Fighting and Proximity Fire Fighting. In addition to being compliant to NFPA-1971:2018, the NFPA-compliant Bourkes are also compliant to ANSI/ISEA Z87.1:2015 as an impact protector (Z87+). Easy to deploy or stow, the new NFPA compliant Bourkes have an increased coverage area of approximately 20% over traditional Bourkes.

To get your NFPA-compliant Bourkes order P/N 10194911 (NFPA-compliant Bourkes Lens and Hardware Kit for MSA Cairns Leather Helmets)³.



N6A Helmet with NFPA-compliant Bourkes

¹ All MSA Cairns leather fire helmets shells are 100% top-grain steer hide.

² Only available on MSA Cairns leather helmets ordered after August 1, 2018.

³ The Bourkes does not affect the compliance of the helmet as shipped from the MSA factory.

Washable Soft Goods for MSA Cairns Leather Fire Helmets

All MSA Cairns Leather Fire Helmets ordered through Assemble-to-Order (ATO) after August 2018¹ offer **only** removable, washable soft goods. Every MSA Cairns Leather Fire Helmet also ships with a **FREE** mesh laundering bag. There are three options available on the ATO: yellow nomex, black nomex or PBI/Kevlar ear cover. Additionally, each of these soft goods is available as a kit, complete with a laundering bag.² *Order an extra set so you can always have a clean one!*

Part No.	Soft Goods Kit Description
10187685	Black Nomex Ear Cover and Liner, Ratchet and Crown Pads, Laundering Bag (for Medium N5A and N6A)
10187686	Black Nomex Ear Cover and Liner, Ratchet and Crown Pads, Laundering Bag (for Large N5A and N6A)
10187688	Yellow Nomex Ear Cover and Liner, Ratchet and Crown Pads, Laundering Bag (for Medium N5A and N6A)
10187689	Yellow Nomex Ear Cover and Liner, Ratchet and Crown Pads, Laundering Bag (for Large N5A and N6A)
10187690	PBI/Kevlar Ear Cover and Liner, Ratchet and Crown Pads, Laundering Bag (for Medium N5A and N6A)
10187691	PBI/Kevlar Ear Cover and Liner, Ratchet and Crown Pads, Laundering Bag (for Large N5A and N6A)

Bronx Bend

Get the historical “rolled” brim style direct from the MSA fire helmet factory. Both the MSA Cairns N5A New Yorker (OSHA compliant) and the N6A Houston (NFPA 1971 compliant) are available with a Bronx Bend (large and medium sizes). All Bronx Bend options come complete with one of three removable soft goods options, and your choice of eye protection¹ (including NFPA-compliant Bourkes).



N6A Helmet with NFPA-compliant Bourkes and Bronx Bend



N5A Helmet with Bronx Bend

Boston Bend

Order your new MSA Cairns N5A New Yorker (OSHA compliant) and the N6A Houston (NFPA 1971 compliant) with the classic Boston Bend, featuring the classic “flat” brim preferred by firefighters throughout New England.



N6A Helmet with Boston Bend (front view)



Boston Bend top view



N6A Helmet with Boston Bend (side view)

Note: All MSA Cairns Leather Fire Helmets with Traditional, Bronx, and Boston Bends are “hand shaped,” including the “bends.” Due to “hand-forming” the bends, no two helmets will be exactly the same.

¹ Removable/washable soft goods are standard on every MSA Cairns Leather Fire Helmet ordered after August 1, 2018.

² The MSA Cairns Leather Fire Helmet washable soft goods are NOT able to be retrofit into leather fire helmets manufactured before August 1, 2018.

MSA Cairns Leather Helmets

N5A New Yorker & N6A Houston

For Structural Firefighting

- The Original Handcrafted Leather Firefighting Helmets
- Hat sizes: Medium (6¾ to 7½) and Large (7 to 8¾)



N5A New Yorker
(shown with
Traditional Bourkes &
Goggles)



N6A Houston
(shown with NFPA Bourkes
and Bronx Bend)

Differences

N5A NEW YORKER	N6A HOUSTON
<ul style="list-style-type: none"> • Meets US-OSHA 1910.156 • Brass “nameplates” where North, East, South and West ribs meet the brim • No Lexan dome • Can be ordered with Traditional Bourkes Eyeshield or other eye protection options 	<ul style="list-style-type: none"> • Meets NFPA 1971 • No brass “nameplates” • Lexan dome for additional penetration protection • Can be ordered with NFPA Bourkes Eyeshield or any other eye protection options*

Features & Benefits

FEATURES	BENEFITS
Leather Shell	100% top-grain high-quality steer hide impregnated with a natural resin system
Crumple-zone Front Holder	Designed to collapse on impact to lessen the impact force
Impact Cap	Provides thermal and impact protection to meet NFPA 1971 and US-OSHA 1910.156
Comfort Pad Kit	Creates a customized fit unlike any other helmet
Aluminum-core Edge Trim	Helps the brim retain its shape
Brim Styles	Traditional, Boston, or Bronx Bend all with historical oak vine pattern
Soft Goods	Nomex (Black or Yellow) or PBI/Kevlar Earlap options; removable/washable**
D-ring Helmet Hanger	Fits on large hooks and resists bending
Removeable Chinstrap	Removable/Washable in 2pt. or 4pt. Available only in Quick Release Buckle (QRB) and Postman’s Slide (PS). See page 36 for details.

Colors

	Black	Yellow	Red	White	Blue
N6A Houston	■	■	■	■	■
N5A New Yorker	■	■	■	■	■

*Traditional Bourkes Eyeshield not available on N6A. ** Available in MSA Cairns leather fire helmets manufactured on or after Aug. 2018.

MSA Cairns N5A New Yorker & N6A Houston Exploded View

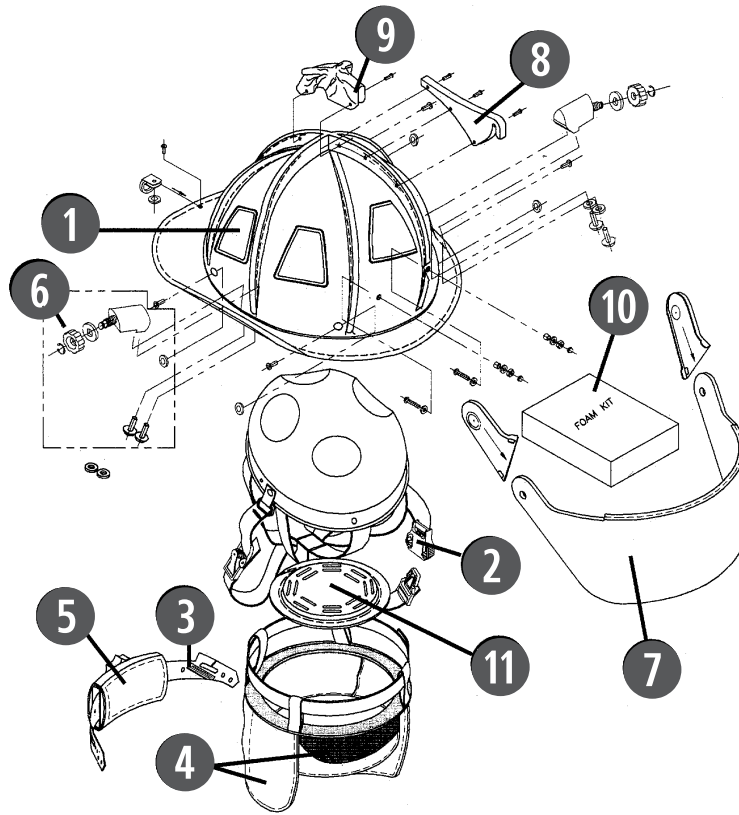

	<i>Replacement P/N Page</i>		<i>Replacement P/N Page</i>		<i>Replacement P/N Page</i>
1 Reflective Trim	60	5 Leather Ratchet Pad	56	9 Brass Crown Piece	60
2 Chinstrap	54	6 Face Shield Hardware	55	10 Foam Adjustment Kit	56
3 Ratchet Headband System	56	7 Face/Eye Protection	55	11 Foam Crown Pad	56
4 Liner/Earlap	57	8 Front Holder	58		

MSA Cairns Leather Helmets

MSA Cairns Leather Helmets

Assemble-to-Order (ATO) Selection Matrix

A	B	C	D	E
Model	Color	Size	Eye/Face Protection	Removable/Washable Earlaps
1 N6A Houston, Standard Bend 3 N5A New Yorker, Standard Bend* 5 G5A Presentation* 6 G64 Presentation* 7 N6A Houston, Bronx Bend 8 N5A New Yorker, Bronx Bend* A N6A Houston, Boston Bend B N5A New Yorker, Boston Bend*	1 Black 2 Red 3 Blue 4 White 5 Yellow 7 Natural *	1 Medium 2 Large	0 None * 1 4" Tuffshield 4 ESS Innerzone 3 Goggle System 5 ESS Innerzone 2 Goggle System with low-profile snap on/snap off hardware* 9 ESS Innerzone 2 Goggle System with side-mounting snap on/ snap off hardware M NFPA Compliant Bourkes A NFPA Compliant Bourkes & Innerzone 3 Goggle B NFPA Compliant Bourkes & Innerzone 2 with side-mounting hardware C Traditional Bourkes*^ D Traditional Bourkes & Innerzone 3 Goggle*^ E Traditional Bourkes & Innerzone 2 with side-mounting hardware*^	4 Liner Cushion (G5A, G64 only) 5 Sateen liner w/Jumbo Nomex Yellow earlap 6 Sateen liner w/Jumbo PBI/Kevlar earlap 7 Sateen liner w/Jumbo Nomex Black earlap

* Not NFPA 1971 compliant

^ Traditional Bourkes are available for N5A New Yorker fire helmets ONLY.



Use this Code to access the latest ATO on MSAFire.com.



F	G	H	I
Front Holder	Removable/Washable Nomex Chinstrap	Trim Type	Trim Color
<ul style="list-style-type: none"> 1 6" Carved Brass Eagle 4 6" Carved Brass Beaver 5 6" Carved Brass Dragon 7 8" Bronze Carved High Eagle (G5A, G64 only) 	<ul style="list-style-type: none"> 0 None (Presentation Helmets only) 2 2-pt w/Quick Release & Postman's Slide, Washable/Replaceable 4 4-pt w/Quick Release & Postman's Slide, Washable/Replaceable 	<ul style="list-style-type: none"> 0 None * 2 Reflexite (Standard) 3 Scotchlite 	<ul style="list-style-type: none"> 1 Lime/Yellow (standard) 2 White * (Reflexite Only) 3 Red/Orange * 4 Red/Orange Triple Trim (Scotchlite Only) 5 Lime/Yellow Triple Trim (Scotchlite Only)

Column: A B C D E F G H I

B-LTH-

PART NUMBER

QUANTITY

Note: Please reference MSA Cairns product pages for up-to-date ATO matrix and available helmet configurations.

MSA Cairns Traditional Helmets

With MSA Cairns, You Get More than You Pay For: 10-Year Warranty¹

We know, as do firefighters, that MSA Cairns Fire Helmets are the most durable products on the market. We back up that claim with a 10-year lifetime warranty that the products will be free from defects in materials and/or faulty workmanship.² When you factor in the quality, ease of maintenance and unique safety features found **ONLY** in MSA Cairns Fire Helmets, it's easy to see why firefighters are **fiercely loyal** to the MSA Cairns brand.

10-Year Warranty and Terms of Sale

MSA Cairns® Fire Helmets



- 1. The Effective Date of this 10-Year Warranty for MSA Cairns Fire Helmets is January 1, 2015.** All MSA Cairns Fire Helmets manufactured on or after January 1, 2015, shall be covered under the warranty. The warranty does not apply to previous or alternative warranties provided with a MSA Cairns Fire Helmet which was manufactured on or after January 1, 2015.
- 2. All MSA Cairns Fire Helmets manufactured between January 1, 2015, shall be covered for the entire lifetime under the previous warranty.**
- 3. Express Warranty:** MSA warrants MSA Cairns Fire Helmets manufactured on or after January 1, 2015, to be free from defects in materials and/or faulty workmanship for a period of ten (10) years from the date of manufacture by MSA. This warranty applies to original assembled components of the fire helmet including shell, respirator, eye protection and accessories. No agent, employee or representative of MSA has any authority to bind MSA to any alteration, representation, or warranty concerning the goods sold hereunder.
- 4. Limited Warranty:** Items designed for normal wear such as reflective trim, ear flaps, goggles, face shields and chinstrap are covered for one year. See "Limited Warranty and Terms of Sale" (3000-115-M2) for warranty details on these products.
- 5. Release of Obligations:** MSA shall be released from all obligations under this warranty in the event that repairs, warranty or modification of the fire helmet is sold by MSA or made by persons other than its own or authorized service personnel, or if the warranty claim results from accident, alteration, misuse, abuse, or normal wear. MSA makes no warranty concerning replacement components, i.e., one that was not part of the original assembly or non-certified accessories, but will agree to the purchase of warranty of manufacturer of such components.

MSA Cairns Fire Helmets meet the current NFPA 181 standard. Testing and training sessions (e.g., "Roll-over" and/or high heat testing) may damage the fire helmet. To avoid such damage, always use an approved helmet cover designed to work with applicable MSA Cairns Fire Helmets. Any heat damage to a fire helmet during testing without an approved cover voids all warranty, repair or replace.

- 6. Exclusion of Remedies:** It is expressly agreed that the Purchaser's sole and exclusive remedy for breach of the above warranty for any fire helmet manufactured by MSA, or for any replacement of a part, shall be repair and/or replacement, at MSA's option, of any component or part thereof that after examination by MSA are proven to be defective. Replacement equipment and/or parts will be provided at no cost to the Purchaser if a defective design is found to be the cause of the defect. Failure of MSA to successfully repair any noncertified product shall not cause the remedy established herein to fail if its essential purpose.
- 7. Exclusion of Accessories:** MSA Cairns Helmets Accessories such as available for purchase by MSA are not part of the certified product and are excluded from the warranty. MSA Cairns Traditional Accessories include but are not limited to: face shields, front cap brackets and Traditional Buckles. See "Limited Warranty and Terms of Sale" (3000-115-M2) for warranty details on these products.
- 8. Exclusion of Consequential Damages:** Purchaser specifically understands and agrees that no consequential damages will be paid to the Purchaser for economic, special, incidental, or consequential damages or losses of any kind whatsoever, including but not limited to, loss of anticipated profits and any other loss caused by reason of the non-occurrence of the goods. This limitation is applicable to claims for breach of warranty, tortious conduct or any other cause of action against MSA. The warranty is in lieu of all other warranties, express, implied or statutory, and is strictly limited to the terms herein. MSA specifically disclaims any recovery of merchantability or of fitness for a particular purpose. In addition, MSA expressly disclaims any liability for economic, special, incidental, or consequential damages in any way connected with the sale or use of MSA products, including but not limited to, loss of anticipated profits.
- 9. MSA reserves the rights to review and update the warranty terms, as needed, to comply with applicable laws or Standards.**

¹10-year warranty applies only to MSA Cairns helmets manufactured on or after January 1, 2015. For details on MSA Cairns Fire Helmet warranties, please see MSAFire.com.

²Limitations apply. See any MSA fire helmet product web page for details at MSAFire.com.



MSA Cairns 1010/1044 Fire Helmets

Offers the most comprehensive impact and thermal head protection system, from top to bottom.

1 Impact Cap

(See page 54 for impact cap replacement part numbers.)

- Fewer components make the new impact cap easier to maintain and clean, as well as upgrade with the Defender Visor
- Defender® Visor automatically installed or enabled—no additional cap or hardware needed. Just order your Defender Visor kit
- Fits head sizes 6-3/8 to 8-3/4
- Designed to accommodate a 2-point or 4-pt chinstrap to help improve helmet retention.
- With the nape arm/speedy button mechanism, the nape strap location is adjusted in seconds—without tools!
- Easy to retrofit into your current 1010/1044 MSA Cairns Helmet

2 Defender Visor

- Retractable eyewear system that stows neatly, cleanly, and securely inside the helmet
- Deploys quickly, even with a gloved hand
- Features quick disconnect for fast, tool-free lens change
- Optically correct lens helps eliminate peripheral distortion
- Available new or as user-upgrade kit
- New impact cap comes with upgrade hardware built right in for significant time and money savings!
- Clear replacement lenses are on the **sos** program

3 Soft Goods

- Simple to replace or take out to launder
- Replacement kits include mesh laundering bag and are available for various combinations of liners and ear laps
- Popular kits are on the **sos** program
- Easy to order part numbers for extra soft goods and kits
- PBI/Kevlar as well as underchin extension, also available for earlaps
- Chinstraps are removable, washable and replaceable*

4 Helmet Shell

- Flexes with impact to absorb energy
- Lower profile than many competitors' helmets
- Fiberglass composite can be painted and is available as the 1010 (eight colors); unpainted shells are available as the 1044 (five colors)

5 Suspension and Retention Systems

- Unique Shell Release System (SRS) helps to maintain impact cap on your head if helmet shell is dislodged
- Exclusive headband interface provides easy adjustment to fit a variety of SCBAs
- Provides a deep, stable fit while allowing enough crown clearance for maximum impact protection
- Standard 6-point configuration



*Available as a replacement part, as well as on any MSA Cairns Fire Helmet manufactured on or after Jan. 1, 2020.

MSA Cairns Traditional Helmets

1010 & 1044

For Structural & Proximity Firefighting

- Two of our most popular MSA Cairns fire helmet models:
 - 1010: painted high-luster finish
 - 1044: unpainted matte finish
- Certified to NFPA 1971 (Structural and Proximity)
- Certified for proximity firefighting (with bonnet, shroud and gold-coated face shield)
- Hat sizes: 6¾ to 8¾



MSA Cairns 1010 (shown with NFPA Bourkes Eyeshield)



MSA Cairns 1044 (shown with Defender Visor)

Features & Benefits

FEATURES	BENEFITS
Impact/Thermal Cap	Provides thermal and impact protection through an impact-resistant polymer liner covered by a high-temperature, energy-absorbing urethane foam
Warranty	10 years¹
Made in the U.S.A	Yes ((Berry Compliant models))
Through-color Fiberglass Composite Shell ² (1044-unpainted/1010-painted)	Maintains color even after taking a beating on the fireground
Available Colors	1044 – black, yellow, red, white, blue 1010 – black, yellow, red, white, orange, blue, pink, green
Retractable Defender Visor (installed or enabled)	Deploys easily when you need it, stores securely inside your helmet shell when you don't. Impact cap comes with upgrade hardware built right in!
Shell Release System (SRS)	Retain your impact cap, suspension system and earlaps if your helmet shell is torn away during a fall or structural collapse
Crumple-Zone Front Holder ³	Designed to collapse on impact to lessen the impact force
Adjustable Nape Height	Three ratchet height positions easily adjusted with the nape arm/speedy button mechanism
Adjustable Headband Height	Helps to provide a perfect fit between your helmet and SCBA mask
Head Size Accommodated	6¾ to 8¾"
Embossed Helmet Brim	Oak vine pattern ties the helmet to 180+ years of MSA Cairns helmet design tradition
D-Ring Helmet Hanger	Fits on large hooks and resists bending
Removable/washable Nomex Chinstrap Options	Removable/Washable in 2pt. or 4pt. Available only in Quick Release Buckle (QRB) and Postman's Slide (PS). See page 36 for details.
ARFF Proximity System Available	Yes

Colors Colors shown are approximate.

	Black	Yellow	Red	White	Orange	Blue	Pink	Green
MSA Cairns 1010	■	■	■	■	■	■	■	■
MSA Cairns 1044	■	■	■	■				

¹Helmets manufactured before January 1, 2015 have a limited five year warranty. For details on both warranty policies, please see www.MSAFire.com. Limitations apply.

²Through color is present on blue, red, white and yellow. All others are painted over a white shell.

³Crumple zone front holders are designed to absorb energy from an impact.

1010 & 1044 (w/Defender) Exploded View

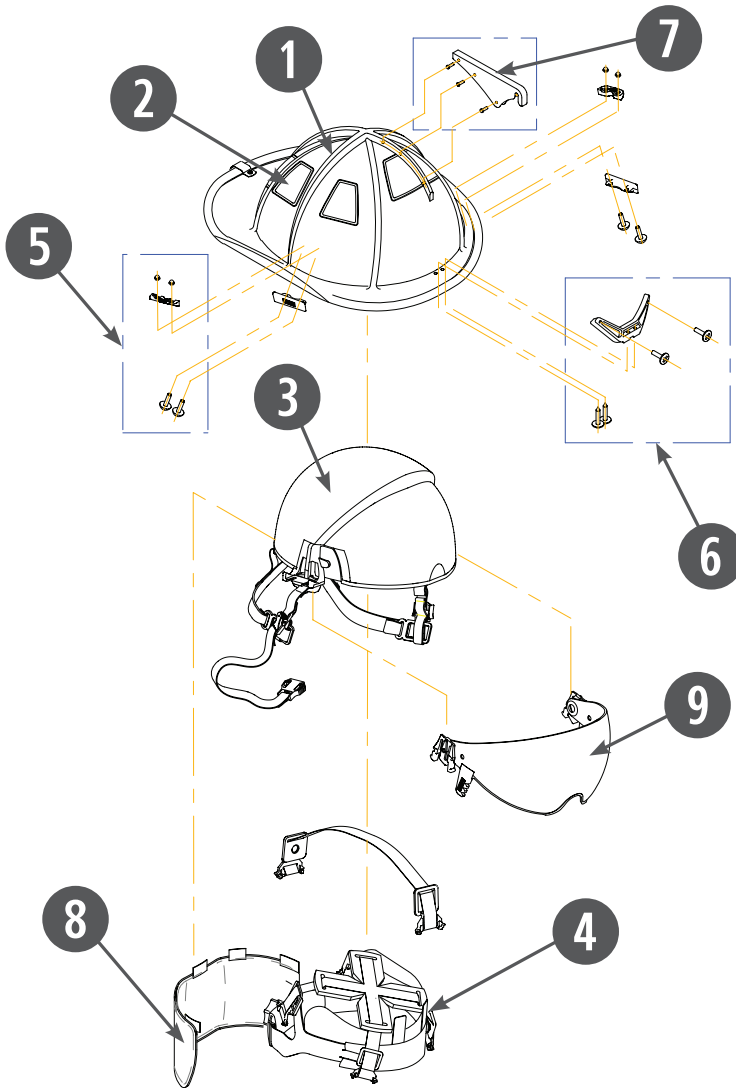

	<i>Replacement P/N Page</i>
1 Shell	—
2 Reflective Trim	60
3 Impact Cap/Chinstrap	54
4 Ratchet Headband System	56
5 Faceshield Hardware	55
6 Front Mounting Bracket	58
7 Front Holder	58
8 Earlap	57
9 Face/Eye Protection	55

Select 1010 & 1044 Helmets available on the  program

We offer our most popular MSA Cairns products in our Stock-Order-Ship (SOS) program. If your SOS order is entered by 2:30 PM, the product ships the same day from our warehouse in Pittsburgh, PA. See page 52–53 for details.

MSA Cairns Traditional Helmets

880 Tradition™

For Structural Firefighting

- Lightweight thermoplastic shell
- Lowest profile traditional helmet
- Accommodates the greatest number of smaller head sizes than any MSA Cairns Fire Helmet
- Certified to NFPA 1971 (Structural)
- Hat sizes: 5% to 7%



MSA Cairns 880
with NFPA Bourke's Eye Shield

Features & Benefits

FEATURES	BENEFITS
Through-color Thermoplastic Shell	Maintains its color even after taking a beating on the fireground
Impact Cap	Provides thermal and impact protection when you need it most
Tube Lock System	Helps protect you from injury by transmitting energy from the suspension to its support and the surrounding foam
Crumple-zone Front Holder	Designed to collapse on impact to lessen the impact force
Adjustable Nape Height	Three ratchet height positions to maximize comfort
Adjustable Headband Height	Helps to provide a perfect fit between your helmet and SCBA mask
Embossed Helmet Brim	Oak vine pattern ties the helmet to over 180 years of MSA Cairns helmet design tradition
D-ring Helmet Hanger	Fits on large hooks and resists bending
Removable/washable Nomex Chinstrap	Removable/Washable in 2pt. only. Available only in Quick Release Buckle (QRB) and Postman's Slide (PS). See page 36 for details.

Colors

	Black	Yellow	Red	White	Orange	Blue
880 Tradition	■	■	■	■	■	■

880 Tradition Exploded View

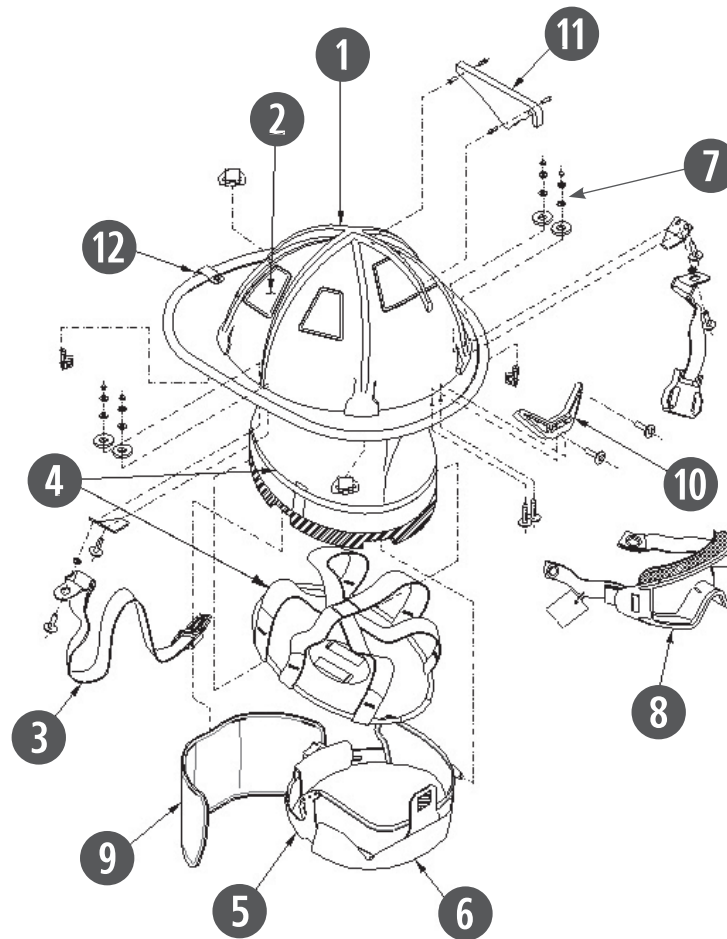

	<i>Replacement P/N Page</i>		<i>Replacement P/N Page</i>
1 Helmet Shell	—	7 Face Shield Hardware	55
2 Reflective Trim	60	8 Eye Protection	55
3 Chinstrap	54	9 Earlap	57
4 Impact Cap and Suspension	54	10 Front Mounting Bracket	58
5 Ratchet Headband System	56	11 Front Holder	58
6 Cushions	56	12 Edge Trim/Helmet Hanger	60

MSA Cairns Traditional Helmets

MSA Cairns Traditional Helmets

Assemble-to-Order (ATO) Selection Matrix

A	B	C	D	E	F
Model	Color	Eye/Face Protection	Headband Liners	Earlaps	Front Holder
<p>1 1010</p> <p>5 880 Tradition</p> <p>7 1044</p>	<p>1 Black</p> <p>2 Red</p> <p>3 Blue ◆</p> <p>4 White</p> <p>5 Yellow</p> <p>6 Orange ◆</p> <p>7 Green ◆</p> <p>8 Pink ◆</p>	<p>1 4" Tuffshield</p> <p>2 Cairns 550 Goggles</p> <p>4 ESS Innerzone 3 Goggles</p> <p>5 ESS Innerzone 2 Goggles w/ low profile hardware</p> <p>8 6" Gold-Coated Faceshield **‡</p> <p>B Defender Visor, Clear ‡</p> <p>C Defender Visor, Amber Tuffshield ‡</p> <p>E ESS Innerzone 2 w/side-mount hardware</p> <p>M NFPA compliant Bourkes</p>	<p>1 Economy Flannel †</p> <p>2 Standard Flannel</p> <p>3 Deluxe Leather w/Crown Pad, 880</p> <p>4 Deluxe Leather, 1010/1044</p>	<p>1 Yellow Nomex</p> <p>2 Yellow Nomex w/Underchin Extension</p> <p>3 PBI/Kevlar</p> <p>9 CFR Aluminized Bonnet w/PBI/Kevlar Shroud & Nomex Earlap ‡§</p> <p>A Black Nomex</p> <p>B Black Nomex w/Underchin Extension</p>	<p>0 None</p> <p>1 6" Carved Brass Eagle</p> <p>2 6" Silk Screened Eagle</p> <p>3 6" Silk Screened Maltese Cross</p> <p>6 6" Carved Brass Beaver ‡</p> <p>7 6" Carved Brass Dragon ‡</p>

◆ Not available on 1044

‡ Not available with 880 Tradition

† Available with 880 Tradition only

* Not NFPA 1971 compliant

** Compliant to NFPA 1971 Proximity Firefighting ONLY.

§ Not NFPA-1971 compliant when used with a Front Holder



Use this Code to access the latest ATO on MSAFire.com.



MSA Cairns Modern Fire & Rescue Helmets

660C Metro & Invader 664

For Structural & Proximity Firefighting

- Two most popular modern helmet models:
 - 660C: painted high-luster finish
 - 664: unpainted matte finish
- Sleek, low-profile design
- Certified to NFPA 1971 (Structural and Proximity)
 - Certified for proximity firefighting (with bonnet, shroud, and gold-coated face shield)
 - Hat sizes: 6 $\frac{1}{2}$ to 8 $\frac{1}{2}$
 - Accommodates largest head sizes of any MSA Cairns Fire Helmet



MSA Cairns 660C Metro (shown with Defender visor)



MSA Cairns Invader 664 (shown with Defender visor)

Features & Benefits

FEATURES	BENEFITS
Through-color Fiberglass Composite Shell	Maintains its color even after taking a beating on the fireground
Impact Cap	Provides thermal and impact protection when you need it most
Shell Release System	Retain your impact cap and earlaps if your helmet shell is torn away during a fall or structural collapse
Defender Visor Retractable Eye Protection	Deploys easily when you need it, stores securely inside your helmet shell when you don't
Adjustable Nape Height	Three ratchet height positions to maximize comfort
Adjustable Headband Height	Helps to provide a perfect fit between your helmet and SCBA mask
D-ring Helmet Hanger	Fits on large hooks and resists bending
Removable/washable Nomex Chinstrap	Removable/Washable in 2pt. only. Available only in Quick Release Buckle (QRB) and Postman's Slide (PS). See page 36 for details.

Colors

	Black	Yellow	Red	White	Orange	Blue	Green	Pink
660C Metro	■	■	■	■	■	■	■	■
Invader 664	■	■	■	■				

**660C Metro Defender
& Invader 664 Defender Exploded View**

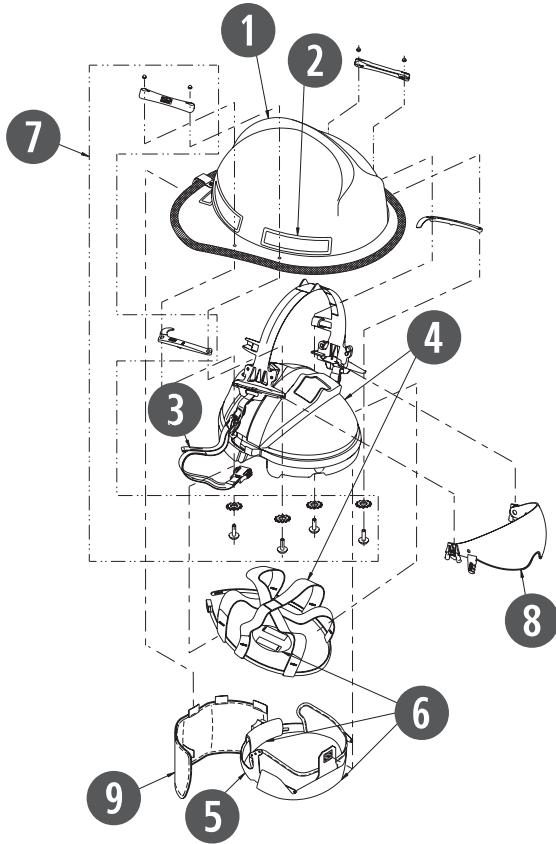

660C Metro & Invader 664 Exploded View

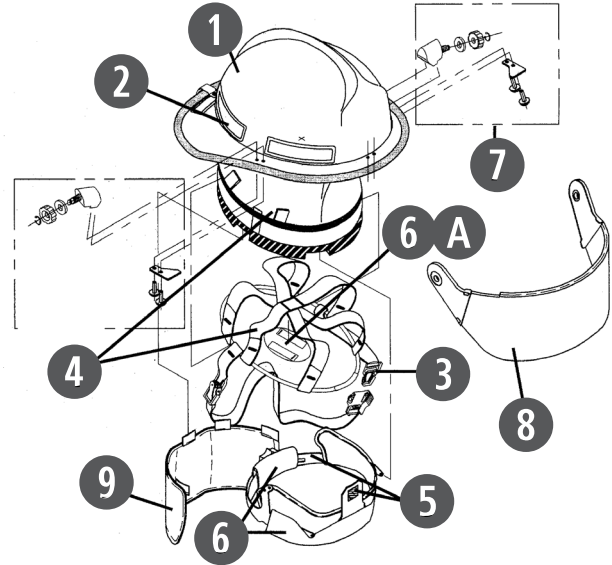

	<i>Replacement P/N Page</i>		<i>Replacement P/N Page</i>		<i>Replacement P/N Page</i>
1 Helmet Shell	—	4 Impact Cap and Suspension	54	7 Face Shield Hardware	55
2 Reflective Trim	60	5 Ratchet Headband System	56	8 Face/Eye Protection	55
3 Chinstrap	54	6 Cushions	56	9 Earlap/Protective Hood	57
		6 A Crown Pad	56		

Select 660C & 664 Fire Helmets available on the  program

We offer our most popular MSA Cairns products in our Stock-Order-Ship (SOS) program. If your SOS order is entered by 2:30 PM, the product ships the same day from our warehouse in Pittsburgh, PA. See page 52-53 for details.

MSA Cairns Modern Fire & Rescue Helmets

Commando HP3

For Structural Firefighting & USAR

- Sleek, low profile design
- Same shell as 660C with back watershed trimmed off
- Lightest fiberglass helmet
- Painted high-luster finish
- Certified to NFPA 1971 & 1951
- Hat sizes: 6 $\frac{3}{8}$ to 8 $\frac{3}{8}$



(shown with Defender visor)

Features & Benefits

FEATURES	BENEFITS
Through-color Fiberglass Composite Shell	Maintains its color even after taking a beating on the fireground
Impact Cap	Provides thermal and impact protection when you need it most
Defender Visor Retractable Eye Protection	Deploys easily when you need it, stores securely inside your helmet shell when you don't
Adjustable Nape Height	Three ratchet height positions to maximize comfort
Adjustable Headband Height	Helps to provide a perfect fit between your helmet and SCBA mask
D-ring Helmet Hanger	Fits on large hooks and resists bending
Removable/washable Nomex Chinstrap	Removable/Washable in 2pt. or 4pt. Available only in Quick Release Buckle (QRB) and Postman's Slide (PS). See page 36 for details.

Colors

	Black	Yellow	Red	White	Orange	Blue	Green
Commando HP3	■	■	■	■	■	■	■

Commando HP3 Defender Exploded View

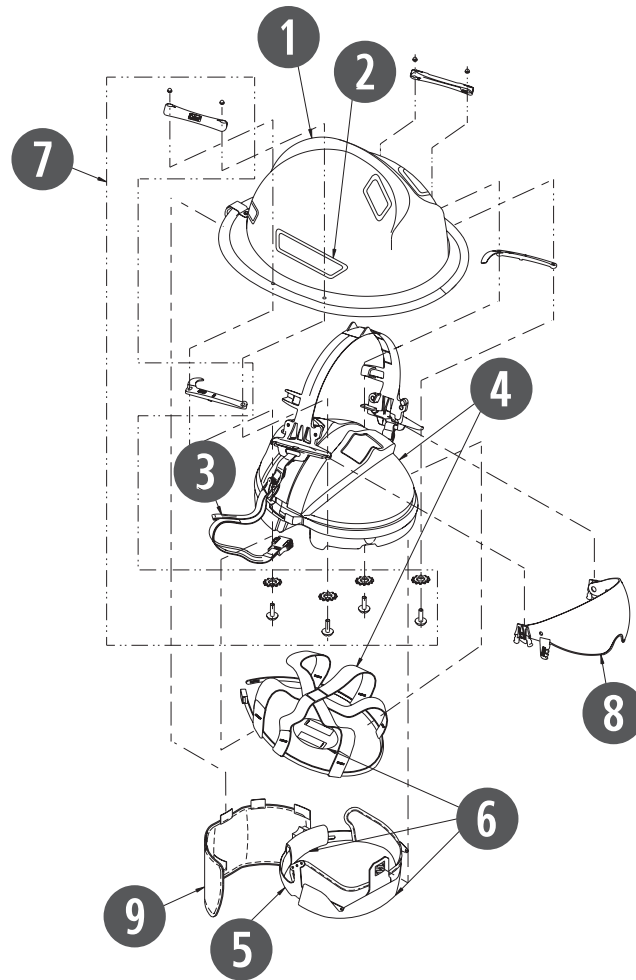

	<i>Replacement P/N Page</i>		<i>Replacement P/N Page</i>
1 Helmet Shell	—	6 Cushions	56
2 Reflective Trim	60	7 Face Shield Hardware	55
3 Chinstrap	54	8 Face/Eye Protection	55
4 Impact Cap and Suspension	54	9 Earlap	57
5 Ratchet Headband System	56		

MSA Cairns Modern Fire & Rescue Helmets

Structural 360S Thermoplastic Helmets

For Structural Firefighting

- Light-weight, low-profile design
- Thermoplastic outer shell
- Structural 360S certified to NFPA 1971
- Hat sizes: 6¾ to 7¼



MSA Cairns Structural 360S
(shown with ESS Innerzone 3 Goggles)

Features & Benefits

FEATURES	BENEFITS
Through-color Thermoplastic Shell	Maintains its color even after taking a beating on the fireground
Impact Cap	Provides thermal and impact protection when you need it most
Adjustable Nape Height	Three ratchet height positions to maximize comfort
Adjustable Headband Height	Helps to provide a perfect fit between your helmet and SCBA mask
D-ring Helmet Hanger	Fits on large hooks and resists bending
Removable/washable Nomex Chinstrap	Removable/Washable in 2pt. or 4pt. Available only in Quick Release Buckle (QRB) and Postman's Slide (PS). See page 36 for details.

Colors

	Black	Yellow	Red	White	Orange	Blue
360 Series	■	■	■	■	■	■

Structural 360S Exploded View

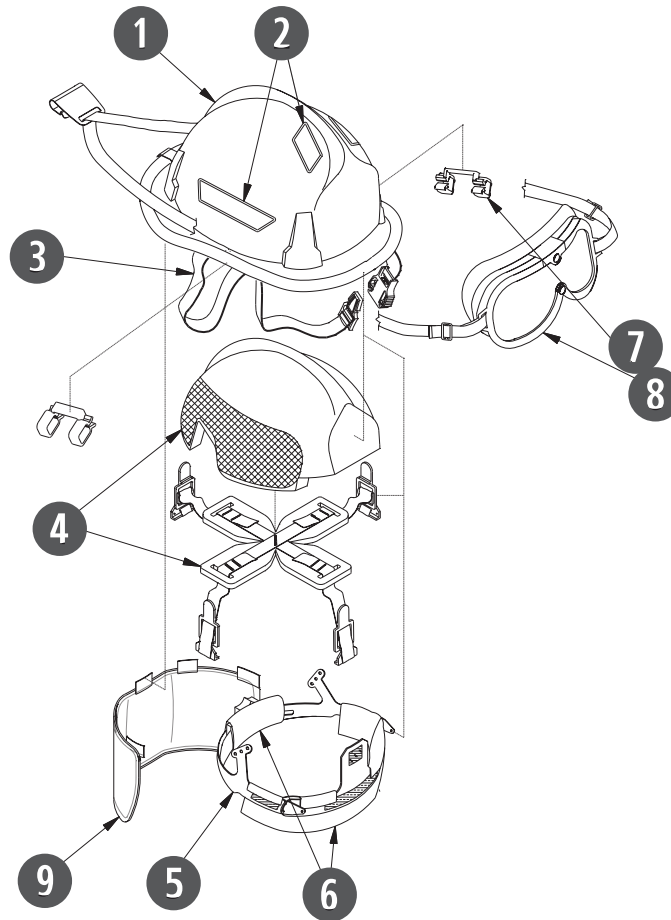

	<i>Replacement P/N Page</i>		<i>Replacement P/N Page</i>
1 Helmet Shell	—	6 Cushions	56
2 Reflective Trim	60	7 Face Shield Hardware	55
3 Chinstrap	54	8 Face/Eye Protection	55
4 Impact Cap and Suspension	54	9 Earlap	57
5 Ratchet Headband System	56		

MSA Cairns Modern Fire & Rescue Helmets

MSA Cairns Modern Fire & Rescue Helmets

Assemble-to-Order (ATO) Selection Matrix

A	B	C	D	E
Model	Color	Eye/Face Protection	Headband Liners	Earlap
<p>2 660C Metro</p> <p>6 Structural 360S</p> <p>A Invader 664</p> <p>D 660C Metro Defender</p> <p>E Invader 664 Defender</p> <p>G Commando HP3 ■</p>	<p>1 Black</p> <p>2 Red</p> <p>3 Blue ‡</p> <p>4 White</p> <p>5 Yellow</p> <p>6 Orange ‡</p> <p>7 Green † ‡</p> <p>8 Pink † ‡</p>	<p>0 None *</p> <p>1 4" Tuffshield</p> <p>2 Cairns 550 Goggles</p> <p>4 ESS Innerzone 3 Goggles</p> <p>5 ESS Innerzone 2 Goggles w/side-mount hardware</p> <p>7 4" Standard Faceshield</p> <p>A 6" Gold-Coated Faceshield ●</p> <p>C Defender Visor, Clear</p> <p>D Defender Visor, Amber Tuffshield</p> <p>G ESS Innerzone 2 Goggle w/low profile clip</p>	<p>1 Economy Flannel</p> <p>2 Standard Flannel</p> <p>3 Deluxe Leather w/Crown Pad</p>	<p>0 None *</p> <p>1 Yellow Nomex</p> <p>2 Yellow Nomex w/Underchin Extension</p> <p>3 PBI/Kevlar</p> <p>8 Black Nomex w/Underchin Extension **</p> <p>9 CFR Aluminized Bonnet w/PBI/Kevlar Shroud & Nomex Earlap ●</p> <p>A Black Nomex</p>

■ Available with eye protection options 4, C or D.

‡ Not available on Invader 664

† Not available on 360S

* Not NFPA 1971 compliant

● Non-Defender 660C/664 only

◆ HP3 only

** Not available on 664/660C Non-Defender and HP3.

* NFPA compliant as Triple Trim only

‡ NFPA compliant in lime/yellow only on all modern helmets

† NFPA compliant in lime/yellow and on 660C/664 only



Use this Code to access the latest ATO on MSAFire.com.



F	G	H	I	J
Removable/Washable Nomex Chinstrap	Trim Type	Trim Color	Trim Shape	Accessory Bracket
<p>2 2-pt w/Quick Release & Postman's Slide</p> <p>3 2-pt w/Quick Release & Postman's Slide, 7.5" longer **</p> <p>7 3-pt w/Quick Release & Postman's Slide, ◆</p>	<p>0 None *</p> <p>2 Reflexite (Standard)</p> <p>3 Scotchlite</p>	<p>1 Lime/Yellow (standard)</p> <p>2 Red/Orange *</p> <p>3 Blue * (Reflexite only)</p> <p>4 White *</p>	<p>1 Tetrabar ✚</p> <p>2 Bar ✚</p> <p>4 Triple Trim (Scotchlite only)</p>	<p>0 None</p> <p>9 Frontpiece Bracket</p> <p>C Frontpiece Bracket and Frontpiece Installed</p> <p>D Goggle Sleeve</p>

Column: A B C D E F G H I J

C-MOD-

PART NUMBER

QUANTITY

Note: Please reference MSA Cairns product pages for up-to-date ATO matrix and available helmet configurations.

MSA Cairns Jet-Style Helmets

MSA Cairns XF1 Fire Helmets



MEETING FIREFIGHTER NEEDS: BENEFITS OF THE CAIRNS XF1



REDUCED SNAGS

The Cairns XF1 has been engineered as much for comfort and fit as safety. The most obvious feature is what it lacks—the XF1 is brimless. While untraditional, the lack of a brim makes it easier to crawl into tight spaces and retain your helmet.



INTEGRATED ACCESSORIES

The Cairns XF1 offers several optional accessories, like a secondary (ocular) visor, lighting, and communications. All are integrated seamlessly into the design, retaining its sleek profile.¹



EASY TO CLEAN

The Cairns XF1's modular design allows it to be quickly disassembled for thorough inspection, care and maintenance. Plus, the helmet's soft goods are removable, washable and replaceable—all without the use of tools.



LIGHTING THE WAY

This compact light accessory is housed inside the helmet, reducing exposure to heat, flames, and impact. The strategic placement of LED lights on either side of the helmet improves visibility in dark conditions without detracting from others' vision.



PERSONALIZED FIT

Several easy-to-find adjustments can be made enabling the fire helmet fit to be customized to the individual. When it's all said and done, the XF1 doesn't just fit firefighters—it fits most of them comfortably.²



CUSTOMIZED LOOK

The Cairns XF1 is available in four colors, black, white, yellow, and red, and two finishes, matte and glossy, for firefighters to choose a look that fits their style. Front plates, in a variety of colors, black pre-printed and custom printed options, are available.

¹ Accessories are not certified to NFPA; however, their addition to the helmet does not affect NFPA compliance.

² This information is based on Beta trial of 250 participants with various facepieces, including competitor SCBA.

MSA CAIRNS XF1 ACCESSORIES

MSA offers a variety of integrated accessories designed to maximize available headroom while minimizing snag hazards.



CUSTOMIZED FRONT PLATE



INTEGRATED OCULAR VISOR



LIGHT MODULE



COMMUNICATION HEADSET

Cairns XF1 Fire Helmets



Matte Black



Matte Red



Matte White



Matte Yellow



Glossy Black



Glossy Red



Glossy White



Glossy Yellow

Technical Data

SIZE	
<i>Medium</i>	Head sizes from 6½–7¾
<i>Large</i>	Head sizes from 7½–8½
WEIGHT	Base helmet (with full face shield), compliant to NFPA-1971 and NFPA 1951
<i>Medium</i>	55-57 oz. (159 +/- 30 g)
<i>Large</i>	60-62 oz. (170 +/- 30 g)
FINISHES	Matte Glossy
APPROVALS	NFPA 1971, Standard on Protective Ensembles for Structural and Proximity Fire Fighting (current edition) NFPA 1951, Standard on Protective Ensembles for Technical Rescue Incidents (current edition)
SHELL	High temperature thermoplastic (injection molded)
IMPACT LINER	Shock-absorbing polyurethane foam with aramide reinforcement
CHINSTRAP	Kevlar®/Nomex blend
SOFT GOODS & EAR COVERS	Nomex
FULL FACE SHIELD	High temperature thermoplastic with AF/AS coatings



Glossy Blue

Colors

	Black	Red	White	Yellow	Blue*
Cairns XF1	■	■	■	■	■

* Glossy finish only

MSA Cairns Jet-Style Helmets

Helmets

	MATERIAL NO.	SIZE		FINISH		COLOR					OCULAR VISOR
		MED	LARGE	MATTE	GLOSSY	BLACK	RED	WHITE	YELLOW	BLUE	
SOS	GYM101850000-NE16	■		■		■					
	GYM101850000-RD16	■		■			■				
	GYM101850000-BU16	■		■				■			
	GYM101850000-JC16	■		■					■		
SOS	GYL101850000-NE16		■	■		■					
	GYL101850000-RD16		■	■			■				
	GYL101850000-BU16		■	■				■			
	GYL101850000-JC16		■	■					■		
SOS	GYM101850000-NA16	■			■	■					
	GYM101850000-RE16	■			■		■				
	GYM101850000-BA16	■			■			■			
	GYM101850000-JD16	■			■				■		
SOS	GYM101850000-AA16	■			■					■	
	GYL101850000-NA16		■		■	■					
	GYL101850000-RE16		■		■		■				
	GYL101850000-BA16		■		■			■			
	GYL101850000-JD16		■		■				■		
	GYL101850000-AA16		■		■					■	
	GYM111850000-NE16	■		■		■					■
	GYM111850000-RD16	■		■			■				■
	GYM111850000-JD16	■			■				■		■
	GYL111850000-NE16		■	■		■					■
	GYL111850000-RD16		■	■			■				■
	GYL111850000-JD16		■		■				■		■

Accessories/Replacement Parts

MATERIAL NO.	DESCRIPTION
SOS GA1484	XF1 Lighting module
SOS GA1087C	XF1 Ocular visor assembly
GA010002H3	XF1 Boom microphone headset
GA010002H3A	XF1 Boom microphone headset (2 speakers)
10163388	PTT for APX6000/7000
10163389	PTT for XTS5000
GA1162	XF1 Headband liner & ratchet cover kit
GA1160	XF1 Chinstrap assembly
GA1153	XF1 Reflective trim kit, lime yellow
GA1159	XF1 Ear cover
GA1172	Soft goods kit, Cairns XF1



GA1484 Lighting Module



GA1087C Ocular Visor



Front Plates



We offer our most popular MSA Cairns products in our Stock-Order-Ship (SOS) program. If your SOS order is entered by 2:30 PM, the product ships the same day from our warehouse in Pittsburgh, PA. See pages 52-53 for details.

MSA Cairns Presentation Helmets and Keychains

- Great for any firefighter
- For display purposes only

	Front Holder		Color
 <p>G64 Leather Presentation Helmet</p>	6" Carved Brass Eagle		Natural
			White
			Yellow
			Black
			Red
	8" Carved Brass Parade Eagle		White
			Natural
	Front Holder	Size	Color
 <p>G5A Leather Presentation Helmet</p>	6" Carved Brass Eagle	Large	Natural
		Large	White
		Large	Yellow
		Large	Black
		Large	Red
		Medium	Natural
		Medium	White
		Medium	Yellow
	Medium	Black	
	8" Carved Brass Parade Eagle	Large	Natural
		Large	White
		Large	Black
		Large	Red
		Large	Blue
Medium		White	
	Front Holder	Color	Part No.
 <p>880 Tradition Presentation Helmet</p>	6" Silk-screened Eagle	White	10052929
		Yellow	10052930
		Black	10052925
		Red	10052928
		Blue	10052926
		Orange	10052927
	6" Silk-screened Maltese Cross	White	10052935
		Yellow	10052936
		Black	10052931
		Red	10052934
	Blue	10052932	
	Orange	10052933	

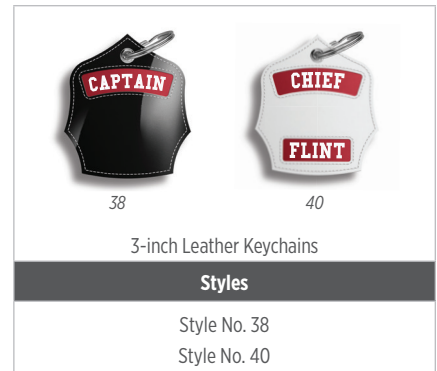
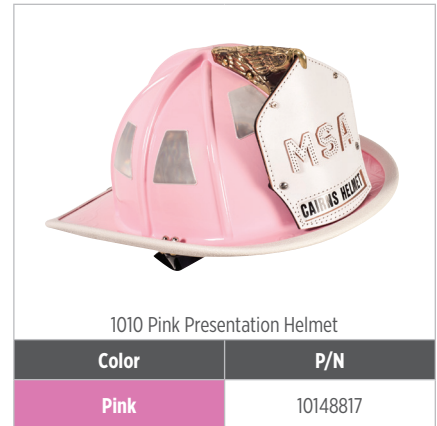

To order leather presentation helmets, see the **Leather Helmet Assemble-to-Order (ATO) Matrix** on pages 12-13.

MSA Cairns Components & Options

Chinstraps

See P/Ns on p. 53

		
DESCRIPTION	Removable/Washable Chinstrap with QRB and Postman's slide	2-point Black Nomex w/QRB & Postman's Slide

In 2018, MSA Cairns led the industry by offering removable and replaceable soft goods for all structural firefighting helmets. Beginning January 2, 2020, and to maintain alignment with cancer prevention directives recommended by the Firefighter Cancer Support Network (FCSN), MSA Cairns will offer removable, replaceable and washable chinstraps.



Model 660 shown with Chinstrap 10204157

Model N6A Boston Bend shown with Chinstrap 10207044

1044 w/Defender shown with Chinstrap 10204155

Removable/Washable Chinstrap Features

- **Removable/Washable**—The chinstraps are easily removed and replaced so they can be cleaned with other fire helmet soft goods.¹
- **Compliant**—The chinstraps are certified to NFPA 1971-2018 and NFPA 1951-2013 to work on MSA Cairns® Fire Helmets.
- **Shell Release System (SRS)**—The chinstraps maintain the benefit of the Shell Release System (SRS) on the helmets that offer this feature.²
- **Retrofit/Upgrade**—The new chinstraps are easily retrofittable to MSA Cairns Fire Helmets currently in service (manufactured on or before December 2019).³
- **Standard Offering**—The NEW Standard on ALL MSA Cairns Helmets manufactured after January 2, 2020.
- **Ease of Ordering**—With the implementation of the new chinstraps, ONLY chinstraps with Quick Release Buckle (QRB) and Postman's Slide (PS) will be offered.

All MSA Fire Helmets manufactured on or after January 2, 2020, have the new Removable/Washable Chinstraps installed as a standard.

¹ The new chinstraps were washed up to 52 times using the instructions provided in the operating manual.

² SRS is offered on the 1010/44 and 660C/664 MSA Cairns Fire Helmets.

³ For 1010/44 fire helmets manufactured prior to November 2015, a 1010/1044 impact cap replacement upgrade kit will be required; these include the removable chinstrap.







Earlaps

Replacement P/Ns: p. 58

				
DESCRIPTION	Yellow Nomex	Black Nomex	PBI/Kevlar	Underchin Extension

Reflective Trim

Replacement P/Ns: p. 60

TRIM SHAPE						
	Tetrahedrons	Triple trim tetrahedrons	Stripes	Diamond	Tetrabars & stripes	Accountability Numbers
TRIM COLORS	Lime/Yellow Red/Orange* Blue*	Lime/Yellow/Silver Red/Orange/Silver	Lime/Yellow Red/Orange* Blue*	Lime/Yellow Red/Orange* Blue*	Lime/Yellow Blue*	White

* Not NFPA 1971 compliant

Eye & Face Protection

Eye protection is a required component on all NFPA-compliant MSA Cairns Helmets. MSA NFPA-compliant eye protection options offer the following features and benefits:

- High-temperature options
- Flame-retardant
- Easy donning and doffing while wearing gloves
- Anti-fog coating on both sides of the lens for visibility
- Anti-scratch coating on both sides of the lens for a longer life
- Easy lens replacement

Defender Visors

Replacement P/Ns: p. 55

Defender Visors offer eye protection from dust, dirt, and grit; their exclusive integral design is retractable for the ultimate in compact convenience. Sleek construction allows fast, easy raising and lowering of the visor even with gloved hands. Standard clear and amber Tuffshield visor options are NFPA-compliant. Defender Visors come standard with black nose-bridge pad.



Clear



Amber Tuffshield



Defender Visor in deployed position



Defender Visor in stowed position

MSA Cairns Fire & Rescue Helmets

Eye & Face Protection

NFPA-Compliant Bourke Eye Shield

The NFPA-compliant Bourke Eye Shield is:

- Available for MSA Cairns Leather N6A,, 1010, 1044 and 880 Fire Helmets on ATOs
- NFPA 1971 compliant
- Side wrapping, with improved coverage compared to Traditional Bourke's
- Fireground-proven, anti-scratch coated, polyarylate lenses
- Lenses are quickly stowed when not in use; easily deployed when needed
- Sturdy metal hardware offers durability under severe fire conditions
- Works with Defender visor or goggles, if additional eye protection is desired
- Available as a replacement kit, complete with lens and hardware
 - PN 10186311 (MSA traditional composite fire helmets)
 - PN 10194911 (MSA leather fire helmets)
- Easy to install—uses the same holes as Traditional Bourke's or shell dimples*

NFPA-compliant Bourkes lenses satisfy NFPA-1971 requirements for eye/face protection and do not require the addition of other eye/face protection.

Replacement P/Ns: p. 55



Faceshields

Replacement P/Ns: p. 55



MSA Cairns
4\"/>

The MSA Cairns 4" Tuffshield offers thermal and scratch resistance. Available for both Traditional and Modern-style Fire Helmets.



MSA Cairns
4\"/>

The MSA Cairns 4" Standard Faceshield is a lower-cost alternative for external visors.

Available on Modern-style Fire Helmets.

The MSA Cairns 6" Gold Faceshield is available on select helmets and is compliant to NFPA 1971 for proximity firefighting ONLY.

All MSA Cairns faceshields come supplied with wing protectors for extra face protection. Wing protectors are made of the same fire-proven material found in MSA Cairns faceshield hardware to provide additional strength at high temperatures.

Goggles

Replacement P/Ns: p. 55

MSA Cairns Firefighter Goggles

Our series of NFPA-compliant firefighters' goggles are certified by an independent test lab to meet the performance requirements of the NFPA 1971, including the test for exposure to 500° F for 5 minutes (Test Method 7.4.4 Heat and Thermal Shrinkage Resistance Test.).

We offer three goggle styles (differentiated by attachment system):



The **Innerzone 2** model has a snap-on/snap-off attachment to structural helmets. The low-profile post design works with all structural firefighting helmets.

**1010/1044 fire helmets only*



The **Innerzone 3** model has a wrap-around strap that attaches to the back of the helmet with two adhesive-backed hook & loop tabs.



The **MSA Cairns 550 Goggle** has a wrap-around strap that attaches to the back of the helmet with a D-Ring fastener.

Front Holders

Replacement P/Ns: p. 58

Our crumple-zone front holders are designed with your safety in mind.

			
DESCRIPTION	Carved Brass Eagle	Carved Brass Beaver	Carved Brass Dragon
			
DESCRIPTION	Silk-Screened Eagle	Silk-Screened Maltese Cross	Carved Brass Parade Eagle*

Standard Fronts

Design your own at www.msanet.com/fronts, and call 1-877-MSA-FIRE to order!

Replacement P/Ns: p. 59

- Over 27 million possible configurations
- Reinforced with high-temperature, shrink-resistant backing
- Sewn with high-temperature, fire-retardant Nomex thread

A Top Layer

Available in...

- High-gloss patent leather
- Low-gloss natural leather

Black	White	Red
Yellow	Blue	Green
Orange	Brown	Gold**

B Print Layer

Available in...

- Luminous (glow-in-the-dark)
- High-temp nylon
- Scotchlite (white only)

Black	White	Red
Yellow	Blue	Green
Orange	Brown	Gold**

C Lettering

- Up to 4 lines
- ½" tall ♦
- 14 characters per line for optimal clarity

Black	White	Red
Yellow	Blue	Green
Orange	Brown	Gold**

D Graphics

- **Attached**
 - Raised or sunken numbers
 - Sunken fleur-de-lis
 - Badges (p. 42)
 - Decals (p. 44)
- **Printed**
 - Custom graphics available
 - Printed graphics (pp. 42-43)
 - Printed numbers
- **None**

Glow-in-the-dark print layer available!



high-gloss patent leather



low-gloss natural leather









*For leather presentation helmets only







** Gold patent.









♦ Except on 3" mini fronts





MSA Cairns Fire & Rescue Helmets

Standard Fronts

TEXT & GRAPHIC POSITION	[GRAPHIC] TEXT		TEXT [GRAPHIC]		TEXT [GRAPHIC] TEXT		TEXT [GRAPHIC] TEXT TEXT		TEXT TEXT [GRAPHIC] TEXT		TEXT TEXT TEXT	TEXT TEXT TEXT TEXT
	Attached	Printed	Attached	Printed	Attached	Printed	Attached	Printed	Attached	Printed	None	None
												
6-Inch (for Traditional Helmets)												
STYLE NO.	19	20	21	22	23	24	25	26	27	28	29	30
5-Inch (for 880 Tradition)												
STYLE NO.	150	151	152	153	154	155	156	157	158	159	160	161

TEXT & GRAPHIC POSITION	[GRAPHIC] TEXT		TEXT [GRAPHIC]		TEXT [GRAPHIC] TEXT		TEXT TEXT TEXT
	Attached	Printed	Attached	Printed	Attached	Printed	None
							
4-Inch (for Modern Helmets)							
STYLE NO.	31	32	33	34	35	36	37

TEXT & GRAPHIC POSITION	[GRAPHIC] TEXT		TEXT [GRAPHIC]		TEXT [GRAPHIC] TEXT		TEXT TEXT [GRAPHIC] TEXT		TEXT TEXT TEXT TEXT
	Attached	Printed	Attached	Printed	Attached	Printed	Attached	Printed	None
									
8-Inch (for G5A and G64)									
STYLE NO.	10	11	12	13	14	15	16	17	18









TEXT & GRAPHIC POSITION	[GRAPHIC] TEXT		TEXT [GRAPHIC]	TEXT TEXT TEXT
	Attached	Printed	Attached	None
				
3-Inch (for Gifts)				
STYLE NO.	38	39	40	41

Passport Fronts for Firefighter Accountability

Replacement P/Ns: p. 59

Improve department accountability with helmet front identification inserts.

- Two (2) front sizes
 - 6" for traditional helmets
 - 4" for modern helmets
- Easy to use
- NFPA 1971 compliant accessory
- Available in same colors as Standard Fronts (p. 39)

	Passport Front Type	Passport Style # for Ordering		
		Frames & Inserts	Frame Only	Insert Only
6" PASSPORT FRONTS	 2 Text Blocks	49	50	51
	 2 Text Blocks	55	56	57
	 No Text Blocks	42	43	48
6" FDNY FRONTS <i>Note: For Velcro-backed passports, add "V" to style # (ex: 44V)</i>	 1 Text Block	44	45	48
	 2 Text Blocks	46	47	48
	 2 Text Blocks	62*	60	61
4" PASSPORT FRONTS	 1 Text Block	58	59	57
	 2 Text Blocks	52	53	54

*Comes with 3 inserts instead of 1

		6" Passport Fronts	6" FDNY Fronts	6" Passport System	4" Passport Fronts
FRAME					
# OF TEXT BLOCKS	No text blocks**		■		
	1 text block		■		■
	2 text blocks	■	■	■	■
INSERT					
ATTACHMENT SYSTEM	Hook & Loop	■	■	■	■
	Removable Pins		■		
NUMBER & LETTER STYLE	Sunken	■	■		■
	Raised	■	■		■
	Printed	■	■	■	■
MAX. # OF CHARACTERS	5 numbers	■	■		■
	5 letters		■		
	5 mixed		■		
	4 numbers			■	
	4 letters	■		■	■
4 mixed	■		■	■	

** Can be ordered with Hot Stamp white numbers on the bottom of the front

MSA Cairns Fire & Rescue Helmets

Badges for Fronts

- Available in Chrome- and 24K Gold-Plate
- Available in 1" and 1 1/2"









						
		1 Axe	2 Axes	1 Trumpet	2 Trumpets	Fireman's Scramble
CHROME-PLATE	1 1/2"	FB21A	FB22A	FB21T	FB22T	FB2S
	1"	—	FB2S2A	—	—	—
24K GOLD-PLATE	1 1/2"	FB11A	FB12A	FB11T	FB12T	FB1S
	1"	FB1S1A**	FB1S2A**	FB1S1T**	FB1S2T**	FB1SS**









					
		2 Crossed Trumpets	3 Crossed Trumpets	4 Crossed Trumpets	5 Crossed Trumpets
CHROME-PLATE	1 1/2"	FB22TX	FB23TX	FB24TX	FB25TX
	1"	—	FB2S3TX	FB2S4TX	FB2S5TX
24K GOLD-PLATE	1 1/2"	FB12TX	FB13TX	FB14TX	FB15TX
	1"	FB1S2TX**	FB1S3TX**	FB1S4TX**	FB1S5TX**

** For Front Style #35 only

Printed Graphics for Fronts

- Three sizes: 1", 1 1/4" and 2"
- Custom printed graphics available upon request







									
	1 Horizontal Trumpet	1 Vertical Trumpet	1 Horizontal Axe	1 Vertical Axe	2-Trumpet Burst	3-Trumpet Burst	4-Trumpet Burst	5-Trumpet Burst	Fireman's Scramble
ID	A	B	C	D	E	F	G	H	I







									
	2 Vertical Trumpets	2 Vertical Axes	Fleur de Lis	EMS Star of Life	Fire Marshall	Chaplain's Cross	Shamrock	American Flag	Maltese Cross
ID	J	K	L*	M	N**	P	Q	R	T







*Available only as a sunken cutout

Printed Graphics

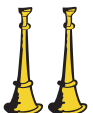
- Available in vinyl or reflective Scotchlite
- Sizes: 1", 1½" and 2½"
- Custom decals also available







							
		Fire Department	Chief	Deputy Chief	Ass't Chief	1st Ass't Chief	2nd Ass't Chief
VINYL	1"	10123025	10123029	10123033	10123037	10123018	10123042
	1½"	10123023	10123027	10123031	10123035	10123016	10123020
	2½"	D101P	D102P	D103P	D104P	D105P	D106P
SCOTCHLITE	1"	10123026	10123030	10123034	10123038	10123019	10123043
	1½"	10123024	10123028	10123032	10123036	10123017	10123041
	2½"	DS101P	DS102P	DS103P	DS104P	DS105P	DS106P





							
		Batt'n Chief	Chief Engineer	Fire Marshall	Platoon Chief	Engineer	Captain w/2 Trumpets
VINYL	1"	10123046	10123050	10123190	10123214	10123218	10123222
	1½"	10123044	10123048	10123188	10123212	10123216	10123220
	2½"	D107P	D108P	D114P	D130P	D109P	D110P
SCOTCHLITE	1"	10123047	10123051	10123211	10123215	10123219	10123223
	1½"	10123045	10123049	10123189	10123213	10123217	10123221
	2½"	DS107P	DS108P	DS114P	DS130P	DS109P	DS110P

							
		Lieut. w/1 Trumpet	Captain w/2 Axes	Lieut. w/1 Axe	Sergeant	Paramedic	2 Trumpets
VINYL	1"	10123226	10123230	10123234	10123238	10123242	10123246
	1½"	10123224	10123228	10123232	10123236	10123240	10123244
	2½"	D111P	D112P	D113P	D115P	D129P	D121P
SCOTCHLITE	1"	10123227	10123231	10123235	10123239	10123243	10123247
	1½"	10123225	10123229	10123233	10123237	10123241	10123245
	2½"	DS111P	DS112P	DS113P	DS115P	DS129P	DS121P

MSA Cairns Fire & Rescue Helmets

Decals

							
		1 Trumpet	5-Trumpet Burst	4-Trumpet Burst	3-Trumpet Burst	2-Trumpet Burst	Fireman's Scramble
VINYL	1"	10123250	10119010	10119012	10119014	10119016	10119020
	1½"	10123248	D123P	D124P	D125P	D126P	D128P
	2½"	D122P	10119039	10119041	10119043	10119045	10119049
SCOTCHLITE	1"	10123251	10119011	10119013	10119015	10119017	10119021
	1½"	10123249	DS123P	DS124P	DS125P	DS126P	DS128P
	2½"	DS122P	10119040	10119042	10119044	10119046	10119050

						
		EMS Star of Life	Chaplain's Cross	Shamrock	American Flag	Custom Decal*
VINYL	1"	10119022	10119024	10119026	10119057	—
	1½"	D131P	D133P	D134P	D135P	—
	2½"	D116P	10119053	10119055	10119057	D99P
SCOTCHLITE	1"	10119023	10119025	10119028	10119058	—
	1½"	DS131P	DS133P	DS134P	DS135P	—
	2½"	DS116P	10119054	10119056	10119058	—

*50-unit minimum required

Title Tapes

- Custom decals only
- Packaged minimum order quantity is 20
- Minimum order quantities do not apply to Assemble-to-Order (ATO) products
- For Modern style helmets only
- Lettering is all-caps; 14 character limit
- Available in vinyl or reflective Scotchlite

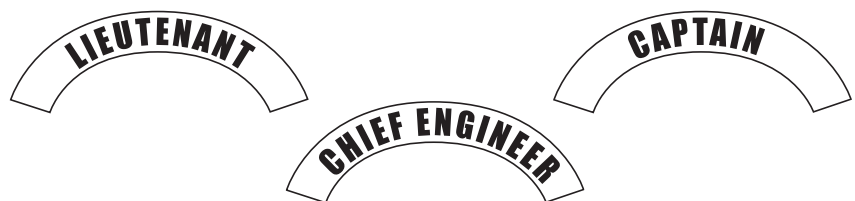

Printed Gold Fronts

- High-temperature construction is stable up to 500°F
- Standard designs available in 2-3 weeks

Replacement P/Ns: p. 59



Standard 6" Printed Gold Fronts

STYLE	F74B	F74S	F74F	F75B	F75S	F75F	F76B	F76S
STYLE	F76F	F77B	F77S	F77F	F78	F79	F80	F81

Standard 4" Printed Gold Fronts

STYLE	F82B	F82S	F83A	F83B

MSA Cairns Fire & Rescue Helmets

Printed Gold Fronts

Replacement P/Ns: p. 59

Choose from 3 backgrounds, 4 scrollwork designs, 9 graphics and 9 text/graphic arrangements. Or create a custom design!

- High-temperature construction is stable up to 500°F
- Standard designs available in 2-3 weeks
- Custom designs available for an additional charge. Call 1-877-MSA-FIRE.

1. Choose Background

Satin Gold	Turned Gold	White w/ Gold Accents	
BACKGROUND ID	GSS	GET	WHT



2. Choose Artwork

Classic Banners	Classic Scrolls	Flaming Scrolls	Upward Arch	No Banner or Scroll
ID	B	S	A*	T**

*Use w/ Style 83 only; **Use w/ Styles 79-81 only

3. Choose Graphic

1 Trumpet	1 Axe	2 Trumpets	2 Axes	2-Trumpet Burst	3-Trumpet Burst	4-Trumpet Burst	5-Trumpet Burst	Fireman's Scramble	
GRAPHIC ID	GA	GB	GC	GD	GE	GF	GG	GH	GI

4. Choose Text & Graphic Position

	TEXT [GRAPHIC]	[GRAPHIC] TEXT	[GRAPHIC] TEXT TEXT	TEXT [GRAPHIC] TEXT	[GRAPHIC] TEXT TEXT TEXT	TEXT [GRAPHIC] TEXT TEXT	TEXT TEXT [GRAPHIC] TEXT	[GRAPHIC] TEXT TEXT TEXT TEXT	TEXT TEXT [GRAPHIC] TEXT TEXT
4" FRONT STYLE #	82*	83	—	—	—	—	—	—	—
6" FRONT STYLE #	—	78	79**	74	80**	75	76	81**	77
8" FRONT STYLE #	—	—	—	70	—	71	72	—	73

*Use w/ Artwork ID "A" only; **Use w/ Artwork ID "T" only

Standard Front Order Form

Build your own front at <http://webapps.msanet.com/fronts>

Ordering Instructions

Please complete a separate form for each type of front ordered. Save the file as a PDF and return the completed form(s) to fireorder@MSASafety.com. The free version of **Adobe Acrobat Reader is required to use this form.**

Fronts other than those that can be ordered using the choices below are considered custom fronts. To discuss your custom artwork or logo application needs, please call 1-877-MSA-FIRE or speak with your sales representative.

Standard Fronts

Enter your choices in the boxes to the right of each section.

Total Quantity:

1. Front Size
4", 5" or 6"

2. Style Option
Enter style number from **10** to **41**,
or from **150** to **161**

3. Attachment Option
Punch front(-s) or attach to: **L** – Leather Helmet
P – Plastic Helmet or **K** – Mini Front Key Chain
V – Hook and Loop Attachment (*for 4" fronts only*)
N – No holes needed

4. Front Material
L – Genuine Leather, **P** – High-Gloss Patent Leather

5. Front Color Option
Choose one color: **B** – Black, **W** – White, **R** – Red,
Y – Yellow, **O** – Orange, **C** – Blue, **G** – Green,
N – Natural/Brown or **K** – Gold (*patent only*)

6. INTERNAL USE ONLY
NOTE: MSA Personnel, add Vinyl (V) or White Scotchlite™ (S)

7. Panel Color Option
Choose one color: **B** – Black, **W** – White, **R** – Red,
Y – Yellow, **O** – Orange, **C** – Blue, **G** – Green,
K – Gold or **S** – Reflective White Scotchlite

8. Text Font
Choose one text style:
A FULL BLOCK ACCT. **F CASLON ADBOLD**
B RAPHAEL ACCT. **G DEMIAN BOLD ACCT.**
C ALPHA MEDIUM **H ACADEMY ENGRAVED**
D COPPER GOTHIC **I BREEZE SCRIPT**
E GOUDY BOLD ACCT. **J CLARENDON MEDIUM**

Note: FULL BLOCK ACCT. is default.

9. Panel Text Color Option
Choose one color: **B** – Black, **W** – White, **R** – Red,
Y – Yellow, **O** – Orange, **C** – Blue, **G** – Green, **K** – Gold,
S – Reflective White Scotchlite, **V** – Vinyl, **L** – Luminous
or **N** – No printed text

Company:	_____
Contact:	_____
Phone:	_____
PO #:	_____
<i>For office use only below this line</i>	
SO#:	_____
Shop #:	_____

Fronts Ordering Form

10. Graphic Type
For attached graphics:

S – Sunken Numbers (*not available on 4" fronts*)
R – Raised Sewn Numbers, **K** – 14K Gold Badge,
C – Chrome Badge or **T** – Tin Emblem
F – Fleur-de-lis (*same as panel color*) or **D** – Graphic Decal

For printed graphics:
P – Printed Numbers, **G** – Printed Graphics, or **N** – No Graphics

Note: Add numbers/letters in the order you want to appear on your front in the corresponding text box below (see examples).

11. Graphic Ornament Option
Enter choice from **A** to **R** (*leave blank if not used*)

12. Color of Large Centered Numbers
Size determined by style chosen (*not available on gold leaf*)
Choose one color: **B** – Black, **W** – White, **R** – Red,
Y – Yellow, **O** – Orange, **C** – Blue, **G** – Green, **K** – Gold,
S – Reflective White Scotchlite or **N** – No numbers

13. Shipping Option
A – Loose or **C** – Attached

14. Text
Fill in the appropriate lines of text for your front style up to 23 characters per line. Spaces and punctuation marks each count as one character. Fill in top to bottom and leave any lines not used blank. See examples of text entry on the next page.

LINE 1: _____

LINE 2: _____

LINE 3: _____

LINE 4: _____

Multiple fronts on Order? See page 2 for additional order entry details.

14. Save File as PDF
Email to fireorder@MSAsafety.com

Have another front to add?
Save this file first, then click to add a new form.

Multiple Fronts

Use the corresponding fields below for same style multiple fronts with slight changes to text, and center graphics/numbers.

	Line 1 Additional Text	Line 2 Additional Text	Line 3 Additional Text	Line 4 Additional Text
FRONT 2				
FRONT 3				
FRONT 4				
FRONT 5				
FRONT 6				
FRONT 7				
FRONT 8				
FRONT 9				
FRONT 10				
FRONT 11				
FRONT 12				
FRONT 13				
FRONT 14				
FRONT 15				
FRONT 16				
FRONT 17				
FRONT 18				
FRONT 19				
FRONT 20				
FRONT 21				
FRONT 22				
FRONT 23				
FRONT 24				
FRONT 25				

6" Style #25 Front with Raised Sewn Numbers



LINE 1: TEXT LINE 1
 LINE 2: 2
 LINE 3: TEXT LINE 3
 LINE 4: TEXT LINE 4

6" Style #24 Front with Printed Graphics



LINE 1: TEXT LINE 1
 LINE 2: [Printed Graphic/Ornament]*
 LINE 3: TEXT LINE 3
 LINE 4:

6" Style #19 Front with Sunken Numbers



LINE 1: 1
 LINE 2: TEXT LINE 2
 LINE 3:
 LINE 4:

6" Style #22 Front with Printed Graphics



LINE 1: 1
 LINE 2: TEXT LINE 2
 LINE 3:
 LINE 4:

*NOTE: Leave this line blank when entering text.



Passport Front Order Form

Build your own front at <http://webapps.msanet.com/fronts>

Ordering Instructions

Please copy and complete a separate form for each type of passport front ordered. Save the file as a PDF and return the completed form(s) to fireorder@MSASafety.com. **The free version of Adobe Acrobat Reader is required to use this form.**

Fronts other than those that can be ordered using the choices below are considered custom fronts. To discuss your custom artwork or logo application needs, please call 1-877-MSA-FIRE or speak with your sales representative.

Passport Fronts

Enter your choices in the boxes to the right of each section.

Total Quantity:

1. INTERNAL USE ONLY
 NOTE: MSA Personnel, add 6"FDNY (1), 6" (2), 6" ACCT (3), 4" (4), 5" (5), or 6" WIDE (6)

2. Style Option
 Enter style number from 42 to 62, or from 162 to 185

3. Attachment Option
 Punch front(-s) or attach to: **L** - Leather Helmet
P - Plastic Helmet or **K** - Mini Front Key Chain
V - Hook and Loop Attachment (*for 4" fronts only*)
N - No holes needed

4. Front Material
L - Genuine Leather, **P** - High-Gloss Patent Leather

5. Frame Color
 Choose one color: **B** - Black, **W** - White, **R** - Red, **Y** - Yellow, **O** - Orange, **C** - Blue, **G** - Green, **N** - Natural/Brown or **K** - Gold (*patent only*)

6. INTERNAL USE ONLY
 NOTE: MSA Personnel, add Vinyl (V) or White Scotchlite (S)

7. Insert Color
 Choose one color: **B** - Black, **W** - White, **R** - Red, **Y** - Yellow, **O** - Orange, **C** - Blue, **G** - Green, **N** - Natural/Brown or **K** - Gold (*patent only*)

8. Text Font
 Choose one text style:

A FULL BLOCK ACCT.	F CASLON ADBOLD
B RAPHAEL ACCT.	G DEMIAN BOLD ACCT.
C ALPHA MEDIUM	H ACADEMY ENGRAVED
D COPPER GOTHIC	I BREEZE SCRIPT
E GOUDY BOLD ACCT.	J CLARENDON MEDIUM

Note: FULL BLOCK ACCT. is default.

9. Panel Color
 Choose one color: **B** - Black, **W** - White, **R** - Red, **Y** - Yellow, **O** - Orange, **C** - Blue, **G** - Green, **P** - Pink, **K** - Gold or **S** - Reflective White Scotchlite

Company: _____
Contact: _____
Phone: _____
PO #: _____
For office use only below this line
SO#: _____
Shop #: _____

Fronts Ordering Form

10. Panel Text Color
 Choose one color: **B** - Black, **W** - White, **R** - Red, **Y** - Yellow, **O** - Orange, **C** - Blue, **G** - Green, **K** - Gold, **S** - Reflective White Scotchlite, **V** - Vinyl, **L** - Luminous **P** - Pink or **N** - No printed text

11. Graphic Type
 For attached graphics:
S - Sunken Numbers (*not available on 4" fronts*)
R - Raised Sewn Numbers, **K** - 14K Gold Badge,
C - Chrome Badge or **T** - Tin Emblem
F - Fleur-de-lis (*same as panel color*) or **D** - Graphic Decal
 For printed graphics:
P - Printed Numbers, **G** - Printed Graphics, or **N** - No Graphics

12. Color of Large Centered Numbers
 Size determined by style chosen (*not available on gold leaf*)
 Choose one color: **B** - Black, **W** - White, **R** - Red, **Y** - Yellow, **O** - Orange, **C** - Blue, **G** - Green, **K** - Gold, **S** - Reflective White Scotchlite or **N** - No numbers

13. Shipping Option
A - Loose or **C** - Attached

14. Text
 Fill in the appropriate lines of text for your front style up to 23 characters per line. Spaces and punctuation marks each count as one character. Include centered numbers as one line. Fill in top to bottom in the order you want to appear on your front. See examples of text/number entry on the next page.

LINE 1: _____
 LINE 2: _____
 LINE 3: _____
 LINE 4: _____

Multiple fronts on Order? See page 2 for additional order entry details.

15. Save File as PDF
 Email to fireorder@MSAsafety.com

Have another front to add?
 Save this file first, then click to add a new form.



Multiple Fronts

Use the corresponding fields below for same style multiple fronts with slight changes to text, and center graphics/numbers.

	Line 1 Additional Text	Line 2 Additional Text	Line 3 Additional Text	Line 4 Additional Text
FRONT 2				
FRONT 3				
FRONT 4				
FRONT 5				
FRONT 6				
FRONT 7				
FRONT 8				
FRONT 9				
FRONT 10				
FRONT 11				
FRONT 12				
FRONT 13				
FRONT 14				
FRONT 15				
FRONT 16				
FRONT 17				
FRONT 18				
FRONT 19				
FRONT 20				
FRONT 21				
FRONT 22				
FRONT 23				
FRONT 24				
FRONT 25				

Sample Passport Fronts with Text Location

Style #55 Frame & Insert with Raised Sewn Numbers



LINE 1: TEXT LINE 1
 LINE 2: 28
 LINE 3: TEXT LINE 3
 LINE 4:

Style #44 Frame & Insert with Sunken Numbers



LINE 1: 44
 LINE 2: TEXT LINE 2
 LINE 3:
 LINE 4:

Style #49 Frame & Insert with Raised Sewn Numbers



LINE 1: TEXT LINE 1
 LINE 2: 12
 LINE 3: TEXT LINE 3
 LINE 4:

Style #42 Frame & Insert with Sunken Numbers



LINE 1: 417
 LINE 2:
 LINE 3:
 LINE 4:



Printed Gold Fronts Order Form

Build your own front at MSAnet.com/fronts

Ordering Instructions

Please copy and complete a separate form for each type of front ordered. Give the completed form(s) to your sales representative or fax them to 800-967-0398.

Fronts other than those that can be ordered given the choices below are considered custom fronts. To discuss your custom artwork or logo application needs, please call 1-877-MSA-FIRE or speak with your sales representative.

Company:	_____
Contact:	_____
Phone:	_____
PO #:	_____
----- <i>For office use only below this line</i> -----	
SO#:	_____
Shop #:	_____

Fronts Ordering Form

Printed Gold Fronts

Enter your choices in the boxes to the right of each section.

Total Quantity:

- 1. Style Option**

Enter style number from **70** to **83**

- 2. Shipping Option**

L – Loose or **A** – Attached

- 3. Attachment Option**

Punch front(-s) or attach to:

 - L** – Leather Helmet
 - P** – Plastic Helmet
 - K** – Mini Front Key Chain
 - V** – Hook and Loop Attachment *(for 4" fronts only)*
 - N** – No holes needed
 - G** – Giant Size *(for decoration only)*

- 4. Artwork Option**

Choose from: **B** – Banners, **F** – Flaming Scrolls, **S** – Regular Scrolls,
A – Upward Arch *(for 4" fronts only)*, **T** – No text art *(for 6" fronts only)*

- 5. Graphic Option**

Enter style letters from **GA** to **GI**

- 6. Front Material**

Choose from: **GSS** – Gold Satin, **GET** – Gold Engine Turned or **WHT** – White

- 7. Text**

Fill in the appropriate lines of text for your front style up to 14 characters per line.
Spaces and punctuation marks each count as one character. Fill in top to bottom.

Printed Gold Fronts													
LINE 1													
LINE 2													
LINE 3													
LINE 4													



MSA Cairns Stock-Order-Ship (SOS) Program

MSA offers the most popular Cairns products on our Stock-Order-Ship (SOS) program.

- Same day shipping is offered on SoS-designated products if the order is entered by 2:30 PM (EST).
- SoS products ship from our warehouse in Pittsburgh, PA.
- Look for the  for SoS program products, both online and in the catalog.



STRUCTURAL FIRE HELMETS	
XFI Jet-Style Helmets and Accessories	
P/N	Description
GYM1018500000-NE16	XFI Helmet, medium, matte black
GYL1018500000-NE16	XFI Helmet, large, matte black
GYM1018500000-NA16	XFI Helmet, medium, glossy black
GYL1018500000-NA16	XFI Helmet, large, glossy black
GA1484	XFI Lighting Module
GA1087C	XFI Ocular Visor Assembly
Traditional Helmets	
P/N	Description
1044DDB	1044 Black Fire Helmet with Clear Defender Visor, PBI/Kevlar Earlap, Deluxe Leather Liner, Carved Brass Eagle
10205805	1044 Black Fire Helmet with Clear Defender Visor, Black Earlap, Deluxe Leather Liner, Carved Brass Eagle
1010FSB	Fire Helmet, 1010, FS, Black, Std
1010DSB	1010 Black Fire Helmet with Clear Defender Visor, Yellow Nomex Earlap, Chinstrap with Postman's Slide and Lime Yellow Reflexite Trim
1044DSR	1044 Red Fire Helmet with Clear Defender Visor, Yellow Nomex Earlap, Chinstrap with Postman's Slide and Lime Yellow Reflexite Trim
1044DSB	1044 Black Fire Helmet with Clear Defender Visor, Yellow Nomex Earlap, Chinstrap with Postman's Slide and Lime Yellow Reflexite Trim
1044FSB	Fire Helmet, 1044, FS, Black, Std
Modern Helmets	
P/N	Description
660DSR	660C Red Fire Helmet with Clear Defender Visor, Yellow Nomex Earlap, Chinstrap with Postman's Slide and Lime Yellow Reflexite Trim
660CFSB	Fire Helmet, 660C, FS, Black, Std
660CFSY	Fire Helmet, 660C, FS, Yellow, Std
664FSY	Fire Helmet, 664, FS, Yellow, Std
664FSB	Fire Helmet, 664, FS, Black, Std



SPARE PARTS AND ACCESSORIES	
Eye Protection	
P/N	Description
10194911	NFPA Bourkes for Leather Helmets
S550P	Cairns ESS Goggle
10037315	4" Standard Faceshield with Wing Protectors
10071006	4" Tuffshield (Polyacrylate) Faceshield with Wing Protectors
10077117	Defender Visor, Clear Lens with Hardware
10186311	Kit, EYESHIELD & Hardware, NFPA Bourke
Soft Goods	
P/N	Description
10145416	Liner, Cushion, Std & Pad, Replacement
L655GP	Earlap, Jumbo Grampion, Pkgd.
LCPP	Crown Pad, Packaged
10187685	Soft Goods Kit: Black Nomex Earlaps for Leather (M)
10187686	Soft Goods Kit: Black Nomex Earlaps for Leather (L)
10187688	Soft Goods Kit: Yellow Nomex Earlaps for Leather (M)
10187689	Soft Goods Kit: Yellow Nomex Earlaps for Leather (L)
10160550	Soft Goods Kit: Standard Liner, Yellow Nomex Ear Lap, Velcro Tabs, Mesh Laundering Bag for Cairns 880 Helmets
10160561	Soft Goods Kit: Standard Liner, Black Nomex Ear Lap, Velcro Tabs, Mesh Laundering Bag for Cairns 880 Helmets
10160548	Soft Goods Kit: Standard Liner, Yellow Nomex Ear Lap, Velcro Tabs, Mesh Laundering Bag for All Cairns Helmets, except N5A, N6A and 880
10160549	Soft Goods Kit: Standard Liner, Blacknomex Ear Lap, Velcro Tabs, Mesh Laundering Bag for All Cairns Helmets, except N5A, N6A and 880
LK28P	Standard Flannel Headband and Ratchet Liner
10172739	Standard Liner, Yellow Nomex Ear Lap, Ratchet Pad, Mesh Laundering Bag
10172740	Standard Liner, Black Nomex Ear Lap, Ratchet Pad, Mesh Laundering Bag
Chinstraps	
P/N	Description
10204155	Chinstrap, Standard Length (Removable, Washable); for all Helmets except HP3 w/ Defender and 660/64 Non-Def
10204157	Chinstrap, Standard Length (Removable, Washable) for 660/64 Non-Def
Leather Front Holders	
P/N	Description
M8P	Front Holder, Carved Eagle, Pkg
M6P	Front Holder, Maltese, Silkscreen, M6
Reflective Trim	
P/N	Description
RP16YP	Bars, Reflexite, Lime Yellow, Packaged
RP20YP	Tetrahedrons, Reflexite, Pkgd, Lime Yellow
Training Covers	
P/N	Description
10207281	Training Cover, Traditional Fire Helmets
10207280	Training Cover, Modern Fire Helmets

*Once inventory depleted.

MSA Cairns Replacement Parts



Impact Cap Replacement Kits*

P/N	Description	NSA & NSA	MSA Cairns 1010 & 1044	880 Tradition	660C Metro & Invader 664	Commando HP3	Structural 360S	Rescue 360R	Rescue 360R-13
IMPACT CAP REPLACEMENT KITS W/ POSTMAN'S SLIDE CHINSTRAP									
10170238	Clear Lens and Standard Headband		■						
10170242	Clear Lens and Deluxe Headband		■						
10170239	Tuffshield Lens and Standard Headband		■						
10170243	Tuffshield Lens and Deluxe Headband		■						
10192360	No Defender Lens and Standard Headband		■						
IMPACT CAP REPLACEMENT KITS WITH DEFENDER**									
10092445	Updgrade kit w/QRB, PS, Clear Defender, Standard Liner & Yellow Nomex Earlap				■				
10096895	ICA w/QRB, PS, Standard Liner & Yellow Nomex Earlap				■				
10096829	ICA w/QRB, PS, Standard Liner & Yellow Nomex Earlap					■			
IMPACT CAP REPLACEMENT KITS FOR NON-DEFENDER HELMETS									
10152449	ICA w/ Standard Configuration			■					
10185067	Retainer Ring & Breakaway Tabs Kit			■					
M603P	ICA w/ Standard Configuration				■	■			
M610P	ICA Retention Kit (Tabs, Velcro, Screws)				■				
M802P	ICA w/ Overhead Suspension						■	■	

*Replacing the impact cap, as needed, does not affect the manufacture date of the original helmet ensemble. Helmets should be removed from service no later than 10 years from the original date of manufacture, per NFPA 1851 (current edition). Please see the MSA Cairns Owner Manual for additional details on removal of helmet from service based on routine and advanced maintenance and inspection criteria.

**Upgrade kits needed if Defender visor not previously installed on helmet.

Removable/Washable Chinstraps

P/N	Description	NSA & NSA	MSA Cairns 1010 & 1044	880 Tradition	660C Metro & Invader 664 (w/ Defender)	660C Metro & Invader 664 (non-Defender)	Commando HP3	Structural 360S	Rescue 360R/ 360R-13
REMOVABLE/WASHABLE CHINSTRAPS									
 10204155	2 pt (20.5" long)	■	■	■	■			■	■
10207044	2 pt (28" long)	■	■	■	■			■	■
10204156	2 pt (20.5" long)						■		
 10204157	2 pt (20.5" long)					■			
10204158	3 pt (20.5" long)								■
10204159	3 pt (20.5" long)						■		
10204160	4 pt (20.5" long)	■	■						

- PNs 10204155 and 10204157 will be stocked in the Pittsburgh warehouse and available on the  program.
- With the implementation of the new chinstraps, ONLY chinstraps with Quick Release Buckle (QRB) and Postman's Slide (PS) will be offered.
- QRB only chinstraps have been eliminated from the line due to low volume.

Eye & Face Protection

P/N	Description	MSA & N6A	MSA Cairns 1010 & 1044	Tradition 880	660C Metro & Invader 664	Commando HP3	Structural 3 60S	Rescue 360R	Rescue 360R-13
DEFENDER VISOR									
10077117	Clear Lens w/ Hardware		■		■	■			
10077118	Amber Tuffshield Lens w/ Hardware		■		■	■			
DEFENDER VISOR HARDWARE									
10145812	Replacement Hardware Kit (no lens)		■		■	■			
10101798	Nose Pad Kit (5 pk)		■		■	■			
10077121	Replacement Retainer Tab		■						
10096795	Replacement Retainer Tab				■				
10096796	Replacement Retainer Tab					■			
FACESHIELDS									
10071006	4" Tuffshield w/ Wing Protectors	■	■	■	■				
10037315	4" Standard w/ Wing Protectors			■	■		■		
S606GP	6" Gold-Coated (for proximity firefighting)		■		■				
FACESHIELD HARDWARE									
S918P	Faceshield Hardware Kit	■	■	■					
S910P	Faceshield Hardware Kit				■				
S620P	Faceshield Hardware Kit					■			
S912P	Faceshield Hardware Kit						■		
10063598	Faceshield Nut Kit	■	■	■	■	■	■		
S950P	Faceshield "E" Clips (50 pk)	■	■	■	■	■	■		
S204P	4" Faceshield Wing Protectors (Pair)	■	■	■	■	■	■		
S206P	6" Faceshield Wing Protectors (Pair)	■	■	■	■	■	■		
GOGGLES									
S550P	MSA Cairns 550 Goggle	■*	■	■	■		■		
S549P	ESS Innerzone 2 with Low Profile Hardware Kit	■	■	■	■		■	■	■
10153029	ESS Innerzone 2 Goggle with Side-Mount Hardware Kit					■			
10032882	ESS Innerzone 3	■	■	■	■	■	■	■	■
GOGGLE HARDWARE									
S953P	Goggle Strap Retaining Tabs	■	■	■	■	■	■	■	■
10059535	MSA Cairns ESS Stealth Sleeve	■	■	■	■	■	■		
10029700	Innerzone 2 Hardware (Old Style)	■	■	■	■	■	■	■	■
10052896	Innerzone 2 Low Profile Mounting Kit	■	■	■	■	■	■	■	■
10059814	Innerzone 1 & 2 Replacement Strap Kit	■	■	■	■	■	■	■	■
HARDWARE AND BOURKES LENSES									
10186311	NFPA-compliant Bourkes Lens and Hardware Kit (for 1010, 1044 and 880 ONLY)*		■	■					
10194911	NFPA-compliant Bourkes Lens and Hardware Kit (for N6A and N5A ONLY)*	■							
S10KP**	Traditional Bourkes Lens and Hardware Kit	■							
10189241	Kit, Hole Plugs (10 helmets)***		■						
10086493	Nylon Mini Rivet, Male	■	■	■	■	■	■	■	■
10086494	Nylon Mini Rivet, Female	■	■	■	■	■	■	■	■

* Addition of an NFPA-compliant Bourkes lens does not affect the compliance as indicated on the original fire helmet ensemble as shipped from MSA.

** Not NFPA compliant; for use on NSA leather helmets only.

*** To plug holes created by faceshield hardware when an MSA faceshield is replaced by NFPA-compliant Bourkes.

MSA Cairns Replacement Parts

Headbands, Ratchet Assemblies, and Soft Goods

P/N	Description	MSA & NGA	MSA Cairns 1010 & 1044	880 Tradition	660C Metro & Invader 664	Commando HP3	Structural 360S	Rescue 360R	Rescue 360R-13
HEADBAND ASSEMBLIES AND SELECT SOFT GOODS									
1017752	Suspension Strap & Headband Assembly, Standard		●						
1017753	Suspension Strap & Headband Assembly, Leather		●						
10162871	Standard Headband with Ratchet and Front Liner		●						
10162873	Deluxe Leather Headband with Ratchet and Front Liner		●						
LK27P	Economy Flannel Headband & Ratchet Liner		■		■	■	■	■	■
LK28P	Standard Flannel Headband & Ratchet Liner		■		■	■	■	■	■
LK29P	Deluxe Leather Ratchet & Headband Liner w/ Crown Pad		■		■	■	■	■	■
10186795	Standard Flannel Headband & Ratchet Liner			■					
10186796	Deluxe Leather Ratchet & Headband Liner w/ Crown Pad			■					
L5RP	Leather/Sateen Cushion Liner w/ Yellow Nomex Earlap (L)	❖							
L5RP-0001	Leather/Sateen Cushion Liner w/ Yellow Nomex Earlap (M)	❖							
10097951	Leather/Sateen Cushion Liner w/ Black Nomex Earlap (L)	❖							
10101176	Leather/Sateen Cushion Liner w/ Black Nomex Earlap (M)	❖							
L59RP	Leather/Sateen Cushion Liner w/ PBI/Kevlar Earlap (L)	❖							
L59RP-0001	Leather/Sateen Cushion Liner w/ PBI/Kevlar Earlap (M)	❖							
10187660	Sateen Cushion Liner w/ Yellow Nomex Earlap (L), Washable	◆							
10187659	Sateen Cushion Liner w/ Yellow Nomex Earlap (M), Washable	◆							
10187657	Sateen Cushion Liner w/ Black Nomex Earlap (L), Washable	◆							
10187656	Sateen Cushion Liner w/ Black Nomex Earlap (M), Washable	◆							
10187682	Sateen Cushion Liner w/ PBI/Kevlar Earlap (L), Washable	◆							
10187681	Sateen Cushion Liner w/ PBI/Kevlar Earlap (M), Washable	◆							
RATCHET ASSEMBLIES (NO SOFT GOODS)									
RBP	Ratchet Headband System	■							
RHBP	Ratchet Headband System		▲		■	■	■	■	■
10046721	Ratchet Headband System			■					
M615P	Headband Retention Tabs (set of 4)		■		■	■			
HEADBAND SOFT GOODS									
10162905	Standard Headband Liner & Ratchet Pad		●						
10162906	Deluxe Leather Headband Liner & Ratchet Pad		●						
10145416	Standard Flannel Headband & Ratchet Pad only		▲	■	■	■	■	■	■
10145417	Deluxe Leather Headband & Ratchet Pad w/Crown Pad		▲	■	■	■	■	■	■
LCPP	Flannel Crown Pad		■	■	■	■			
FCPP	Foam Crown Pad	■							
10191684	Flannel Ratchet Pad (washable)	■	■	■	■	■	■	■	■
LRPP	Leather Ratchet Pad	■	■	■	■	■	■	■	■
M560P	Fit Adjustment Kit (6 sets w/ 5 pads in each)	■							

- ▲ For MSA Cairns 1010/44 Fire Helmets manufactured before November 2015.
- For MSA Cairns 1010/44 Fire Helmets manufactured on or after November 2015.
- ◆ For MSA Cairns Leather Fire Helmets shipped before August 1, 2018.
- ❖ For MSA Cairns Leather Fire Helmets shipped on or after August 1, 2018. Replaceable soft goods for leather helmets are only available for fire helmets where replaceable soft goods were part of the original ensemble as shipped from the MSA manufacturing facility.

Soft Goods Kits

P/N	Description	NSA & NGA	MSA Cairns 1010 & 1044	880 Tradition	660C Metro & Invader 664	Commando HP3	Structural 360S	Rescue 360R	Rescue 360R-13
SOFT GOODS KITS									
10160548	Standard Liner, Yellow Nomex Ear Lap, Ratchet Pad, Mesh Laundering Bag		▲		■	■	■	■	■
10160549	Standard Liner, Black Nomex Ear Lap, Ratchet Pad, Mesh Laundering Bag		▲		■	■	■	■	■
10160550	Standard Liner, Yellow Nomex Ear Lap, Ratchet Pad, Mesh Laundering Bag			■					
10160561	Standard Liner, Black Nomex Ear Lap, Ratchet Pad, Mesh Laundering Bag			■					
10164551	Standard Liner, PBI / Kevlar Ear Lap, Ratchet Pad, Mesh Laundering Bag		▲		■	■	■	■	■
10164552	Standard Liner, PBI / Kevlar Ear Lap, Ratchet Pad, Mesh Laundering Bag			■					
10172739	Standard Liner, Yellow Nomex Ear Lap, Ratchet Pad, Mesh Laundering Bag		●						
10172740	Standard Liner, Black Nomex Ear Lap, Ratchet Pad, Mesh Laundering Bag		●						
10172751	Standard Liner, PBI / Kevlar Ear Lap, Ratchet Pad, Mesh Laundering Bag		●						
10172755	Standard Liner, Yellow Nomex Ear Lap with Underchin Extension, Ratchet Pad, Mesh Laundering Bag		●						
10172756	Standard Liner, Black Nomex Ear Lap with Underchin Extension, Ratchet Pad, Mesh Laundering Bag		●						
10186793	Standard Liner, Yellow Nomex Ear Lap with Underchin Extension , Ratchet Pad, Mesh Laundering Bag			■					
10186794	Standard Liner, Black Nomex Ear Lap with Underchin Extension , Ratchet Pad, Mesh Laundering Bag			■					
10187685	Liner/Black Nomex Ear Lap, Ratchet Pad, Crown Pad, Black Mesh Laundering Bag (MED)	❖							
10187686	Liner/Black Nomex Ear Lap, Ratchet Pad, Crown Pad, Grey Mesh Laundering Bag (LG)	❖							
10187688	Liner/Yellow Nomex Ear Lap, Ratchet Pad, Crown Pad, Black Mesh Laundering Bag (MED)	❖							
10187689	Liner/Yellow Nomex Ear Lap, Ratchet Pad, Crown Pad, Grey Mesh Laundering Bag (LG)	❖							
10187690	Liner/PBI/Kevlar Ear Lap, Ratchet Pad, Crown Pad, Black Mesh Laundering Bag (MED)	❖							
10187691	Liner/PBI/Kevlar Ear Lap, Ratchet Pad, Crown Pad, Grey Mesh Laundering Bag (LG)	❖							

▲ For MSA Cairns 1010/44 fire helmets manufactured before November 2015 ONLY.

● For MSA Cairns 1010/44 fire helmets manufactured on or after November 2015 ONLY.

❖ For MSA Cairns Leather Fire Helmets shipped on or after August 1, 2018. Replaceable soft goods for leather helmets are only available for fire helmets where replaceable soft goods were part of the original ensemble as shipped from the MSA manufacturing facility.

MSA Cairns Replacement Parts

Earlaps, ARFF Proximity Hoods, and Training Covers

P/N	Description	NSA & NGA	MSA Cairns 1010 & 1044	880 Tradition	660C Metro & Invader 664	Commando HP3	Structural 360S	Rescue 360R	Rescue 360R-13	XF1
EARLAPS										
L655XP	Yellow Nomex Earlap		■		■	■	■	■	■	
L655AP	Yellow Nomex Earlap w/Under Chin Extension		■		■	■	■	■	■	
L655GP	Black Nomex Earlap		■		■	■	■	■	■	
10124742	Black Nomex Earlap w/Under Chin Extension		■		■	■	■	■	■	
L955P	PBI/Kevlar Earlap		■		■	■	■	■	■	
10187115	Earlap, Jumbo, 880, Yellow Nomex			■						
10187116	Earlap, Jumbo, 880, PBI Kevlar			■						
10187118	Earlap, Jumbo, 880, Yellow Nomex, Underchin			■						
10187119	Earlap, Jumbo, 880, Black Nomex			■						
ARFF PROXIMITY HOODS										
10041994*	Aluminized PBI/Kevlar Shroud		■		■					
10041993*	Aluminized PBI/Kevlar Bonnet				■					
10041992*	Aluminized PBI/Kevlar Bonnet		■							
TRAINING COVERS										
10207280	Training Cover, Modern Fire Helmet				■	■	■	■		
10207281	Training Cover, Traditional Fire Helmet	■	■	■						
GA1137-L	XF1 Training Cover, Large									■
GA1137-M	XF1 Training Cover, Medium									■

* Must have both bonnet and shroud for compliance to NFPA 1971 proximity firefighting requirements.

Front Holders

P/N	Description	NSA & NGA	MSA Cairns 1010 & 1044	880 Tradition	660C Metro & Invader 664	Commando HP3	Structural 360S	Rescue 360R	Rescue 360R-13	
FOR 6" FRONTS										
10099776	Carved Brass Eagle	■								
10099778	Carved Brass Beaver	■								
10128084	Carved Brass Dragon	■								
M8P	Carved Brass Eagle			■						
10071259	Carved Brass Beaver			■						
10128083	Carved Brass Dragon			■						
M9P	Silk-Screened Eagle			■						
M6P	Silk-Screened Maltese Cross			■						
10065952	Carved Brass Eagle				■					
10049738	Silk-Screened Eagle				■					
10049739	Silk-Screened Maltese Cross				■					
FOR 5" FRONTS										
10049736	Silk-Screened Eagle			■						
10049737	Silk-Screened Maltese Cross			■						
FOR 8" FRONTS										
M7P	Carved Brass Parade Eagle									Presentation Helmets Only
HARDWARE										
10047527	Front Holder Hardware Kit (set of 3)	■	■	■						
M16P	Mounting Bracket		■	■						
M12P	Mounting Bracket				■	■	■	■	■	■

* Must have both bonnet and shroud for compliance to NFPA 1971 proximity firefighting requirements.

Fronts & Accessories

P/N	Description	NSA & NGA	MSA Cairns 1010 & 1044	880 Tradition	660C Metro & Invader 664	Commando HP3	Structural 360S	Rescue 360R	Rescue 360R-13
6" FRONTS & ACCESSORIES									
F19P-F30P	6" Front	■	■	■					
F42P/F44P/F46P	FDNY Frame & Insert	■	■	■					
F43P/F45P/F47P	FDNY Frame	■	■	■					
F48P	FDNY Insert	■	■	■					
F49P	Passport Frame & Insert (Rectangular-insert style)	■	■	■					
F50P	Passport Frame (Rectangular-insert style)	■	■	■					
F51P	Passport Insert (Rectangular style)	■	■	■					
F55P	Passport Frame & Insert (Rounded-insert style)	■	■	■					
F56P	Passport Frame (Rounded-insert style)	■	■	■					
F57P	Passport Insert (Rounded style)	■	■	■					
F62P	Passport System Frame & 3 Inserts	■	■	■					
F60P	Passport System Frame	■	■	■					
F61P	Passport System Insert	■	■	■					
M16P	5" & 6" Front Mounting Bracket		■	■					
AN6P	Acorn Nuts for Fronts (50 pk)	■	■	■					
FSMP	Front Mounting Screws (50 pk)	■	■	■					
FPP	Front Pins (100 pk)	■	■	■					
4" FRONTS & ACCESSORIES									
F31P-F37P	4" Front w/M12 Bracket				■	■	■	■	■
F52P	Passport Frame & Insert (2 lines of text)				■	■	■	■	■
F53P	Passport Frame (2 lines of text)				■	■	■	■	■
F54P	Passport Insert (2 lines of text)				■	■	■	■	■
F58P	Passport Frame & Insert (1 line of text)				■	■	■	■	■
F59P	Passport Frame (1 line of text)				■	■	■	■	■
F57P	Passport Insert (1 line of text)				■	■	■	■	■
10101683	4" Front Hook & Loop Kit				■	■	■	■	■
M12P	4" Front Mounting Bracket				■	■	■		
FSMP	Front Mounting Screws (50 pk)				■	■	■		
8" STANDARD FRONTS & ACCESSORIES									
F10P-F18P	8" Front	Leather Presentation Helmets Only							
AN6P	Acorn Nuts for Fronts (50 pk)								
FSMP	Front Mounting Screws (50 pk)								
PRINTED GOLD FRONTS									
F70P-F73P	8" Printed Gold Front	Leather Presentation Helmets Only							
F74P-F81P	6" Printed Gold Front	■	■	■					
F82P-F83P	4" Printed Gold Front				■	■	■	■	■
KEYCHAINS									
39PG	Keychain with 1 panel on top								
40AG	Keychain with panels on top and bottom								
41	Keychain with 3 panels								
FRONT ACCESSORIES									
E101P	Tin Maltese Cross Emblem	■	■	■	■	■	■	■	■
FB1P	Gold-plated Badge	■	■	■	■	■	■	■	■
FB2P	Chrome-plated Badge	■	■	■	■	■	■	■	■

MSA Cairns Replacement Parts

Reflective Trim & Accountability

P/N	Description	NSA & NGA	MSA Cairns 1010 & 1044	880 Tradition	660C Metro & Invader 664	Commando HP3	Structural 360S	Rescue 360R	Rescue 360R-13
TETRAHEDRONS									
RP20YP	Reflexite, Lime/Yellow, 20 per sheet	■	■	■					
RP20RP	Reflexite, Red/Orange, 20 per sheet*	■	■	■					
RP20WP	Reflexite, White, 20 per sheet*	■	■	■					
RP20BP	Reflexite, Blue, 20 per sheet*	■	■	■					
SP20YP	Scotchlite, Lime/Yellow, 20 per sheet	■	■	■					
10062656	Scotchlite, Lime/Yellow w/ silver center bar, 8 per sheet	■	■	■					
10062655	Scotchlite, Red/Orange w/ silver center bar, 8 per sheet	■	■	■					
STRIPES									
RP16YP	Reflexite, Lime/Yellow, 1" x 4", 16 per sheet				■				
RP16RP	Reflexite, Red/Orange, 1" x 4", 16 per sheet*				■				
RP16WP	Reflexite, White, 1" x 4", 16 per sheet*				■				
RP16BP	Reflexite, Blue, 1" x 4", 16 per sheet*				■				
SP16YP	Scotchlite, Lime/Yellow, 1" x 4", 16 per sheet				■				
PG1	Scotchlite, Triple Trim Lime/Yellow/Silver center bar, 6 per pack				■				
PG2	Scotchlite, Triple Trim Red/Orange/Silver center bar, 6 per pack				■				
TETRABARS & STRIPES									
RP17YP	Reflexite, Lime/Yellow, 12 1" x 4" tetrabars & 8 stripes per sheet					■	■	■	■
RP17RP	Reflexite, Red/Orange, 12 1" x 4" tetrabars & 8 stripes per sheet*					■	■	■	■
SP17YP	Scotchlite, Triple Trim Lime/Yellow, 12 1" x 4" tetrabars & 8 stripes per sheet					■	■	■	■
SP17RP	Scotchlite, Red/Orange, 12 1" x 4" tetrabars & 8 stripes per sheet*					■	■	■	■
ACCOUNTABILITY NUMBERS									
Call Customer Service	2" Accountability Numbers, 20 per pack	■	■	■	■	■	■	■	■
AS006	1 3/4" x 2 1/2" Velcro Accountability Tag	■	■	■	■	■	■	■	■

* Not NFPA 1971 compliant

Edge Beading & Other Shell Hardware

P/N	Description	NSA & NGA	MSA Cairns 1010 & 1044	880 Tradition	660C Metro & Invader 664	Commando HP3	Structural 360S	Rescue 360R	Rescue 360R-13
EDGE BEADING									
M5P	Black Edge Beading Replacement Kit		■		■	■	■	■	■
M5P-0001	White Edge Beading Replacement Kit		■		■	■	■	■	■
10049832	Black Edge Beading Replacement Kit			■					
10062602	White Edge Beading Replacement Kit			■					
OTHER SHELL HARDWARE									
M4P	Helmet Hanger Replacement Kit		■		■		■	■	■
10049831	Helmet Hanger Replacement Kit			■					
10113989	Helmet Hanger Replacement Kit					■			
S921P	Acorn Nut Kit	■	■	■	■				
M10P	Brass Crown Piece	■							
10177418	Kit, Replacement Velcro (50 helmets)		■						

PERFORMANCE AND PROTECTION IN PERFECT BALANCE.

Globe gear is designed to meet the new challenges you face every day to help keep you safe and healthy throughout your career and beyond.

ATHLETIX™

- New material technology enables all-new athletic design with unique stretch fabrics that allow closer, body-contoured fit to provide unprecedented range of motion with less bulk, more flexibility, and lighter weight.
- PBI® STRETCH fabric with KEVLAR® allows less bulky fit with unprecedented range of motion and flexibility, while providing thermal break open protection.
- DUPONT™ NOMEX® NANO thermal barrier material is thin, light, and flexible.
- 3M™ SCOTCHLITE™ COMFORT TRIM reflective material is segmented and heat sealed to be light, flexible, and breathable.
- GORE® CROSSTECH® BLACK moisture barrier provides breathability in the widest range of environmental conditions, to reduce heat stress.

Get the full story on ATHLETIX™ and the full line of Globe turnout gear at MSAfire.com/Globe

ATHLETIC FOOTWEAR FOR FIREFIGHTERS.

With a unique cushioned and contoured sole and athletic footwear construction, Globe boots are flexible like your feet, grip like no other, and feel broken-in right out of the box.

SUPRAFLEX™

- Scientific studies have proven that lighter weight and more flexible footwear isn't just about comfort — it's about safety.
- Continuous segmented flex panels make these boots feel like your favorite pair of athletic shoes.
- Recessed pull-on handles are inset on the sides and hidden when not needed.
- Flexible NOMEX® webbing carry loops allow easy carrying when installed in turnout pants.
- Composite safety toe cap, puncture protection, and shank are lighter and far more flexible than steel.

Get the full story on SUPRAFLEX™ and the full line of Globe boots at MSAfire.com/Globe



*For information on MSA Cairns Fire and Rescue Helmets,
or any product in the MSA Fire Service Suite, please contact MSA Customer Service
at 1-877-MSA-Fire or visit our website at www.MSAfire.com.*

Note: This Bulletin contains only a general description of the products shown. While product uses and performance capabilities are generally described, the products shall not, under any circumstances, be used by untrained or unqualified individuals. The products shall not be used until the product instructions/user manual, which contains detailed information concerning the proper use and care of the products, including any warnings or cautions, have been thoroughly read and understood. Specifications are subject to change without prior notice. MSA is a registered trademark of MSA Technology, LLC in the US, Europe, and other Countries. For all other trademarks visit <https://us.msasafety.com/Trademarks>.

MSA operates in over 40 countries worldwide. To find an MSA office near you, please visit **MSAsafety.com/offices**.